























625633 | 625763 | 62540406 | 625404 (HBIR29, HBIR29/H) One DALI output









Product Description

HBIR29 series are Bluetooth PIR standalone motion sensors with one DALI channel output (80mA DALI power supply built in), which can control up to 40 LED drivers. It is ideal for typical indoor applications such as office, classroom, healthcare and other commercial areas. With Bluetooth wireless mesh networking, it makes communication between luminaires much easier without time-consuming hardwiring, which eventually saves costs for projects (especially for retrofit upgrade projects!). Meanwhile, simple device setup and commissioning can be done via Lena Lighting Clue app.











App Features

-  Quick setup mode & advanced setup mode
-  Web app/platform for project deployment & data analysis
-  Koolmesh Pro app on iPad for on-site configuration
-  Floorplan feature to simplify project planning
-  coming soon
-  One-key device replacement
-  Device social relations check
-  Staircase function (primary & secondary)
-  Remote control via gateway support HBGW01
-  Heat map
-  Dynamic daylight harvest auto-adaptation
-  Grouping luminaires via mesh network
-  Scenes
-  Dusk/Dawn photocell (Twilight function)
-  Tri-level control
-  Daylight harvest
-  Circadian rhythm (Human centric lighting)
-  Push switch configuration
-  Detailed motion sensor settings
-  Schedule
-  Astro timer (sunrise and sunset)
-  Power-on status (memory against power loss)
-  Offline commissioning

-  Bulk commissioning (copy and paste settings)
-  Different permission levels via authority management
-  Network sharing via QR code or keycode
-  Interoperability with Hytronik Bluetooth product portfolio
-  Compatible with EnOcean BLE switches
-  Internet-of-Things (IoT) featured
-  Device firmware update over-the-air (OTA)
-  Continuous development in progress...

Hardware Features

-  80mA DALI broadcast output
-  Support to control DT8 LED drivers
-  2 Push inputs for flexible manual control
-  IP20/IP54 Ceiling/Surface mount box available as accessory
-  Two types of blind inserts / blanking plates
-  User-friendly design for installation
-  High bay version available (up to 1.5m in height)
-  5-year warranty



Fully support EnOcean self-powered switch module PTM215B (HBES01/W & HBES01/B)

Smartphone app for both
iOS & Android platform

Web app/platform:
www.iot.koolmesh.com

Technical Specifications

Bluetooth Transceiver	
Operation frequency	2.4 GHz - 2.483 GHz
Transmission power	4 dBm
Range (Typical indoor)	10~30m
Protocol	5.0 SIG Mesh

Input & Output Characteristics	
Operating voltage	220~240VAC 50/60Hz
Stand-by power	< 1W
Switched power	Max. 40 devices, 80mA
Warming-up	20s

Sensor Data	
Sensor Model	PIR detection
HBIR29	Installation Height : 6m Detection Range(Ø) : 9m
HBIR29/R	Installation Height : 6m Detection Range(Ø) : 10m
HBIR29/W	Installation Height : 6m Detection Range(Ø) : 18m
HBIR29/H	Installation height: 1.5m (forklift) 12m (person) Detection range (Ø): 24m
Detection angle	360°

Safety & EMC	
EMC standard (EMC)	EN55015, EN61000, EN61547
Safety standard (LVD)	EN60669-1, EN60669-2-1 AS/NZS60669-1/-2-1
RED	EN300328, EN301489-1/-17
Certification	CB, CE, EMC, RED, RCM

Environment	
Operation temperature	Ta: -20°C ~ +50°C
IP rating	IP20

* For more details of detection range, please refer to "detection pattern" section.

Mechanical Structure & Dimensions

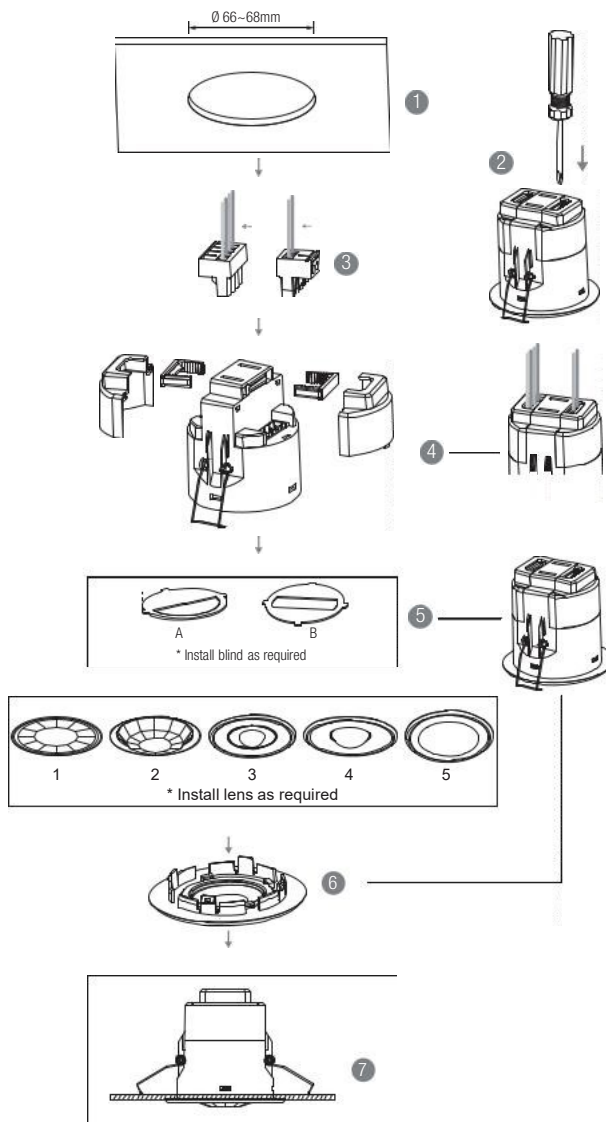

1. Ceiling (drill hole \varnothing 66-68mm)
2. Carefully prise off the cable clamps.
3. Make connections to the pluggable terminal blocks.
4. Insert plug connectors and secure using the provided cable clamps, then clip terminal covers to the base.
5. Fit detection blind (if required) and desired lens.
6. Clip fascia to body.
7. Bend back springs and insert into ceiling.

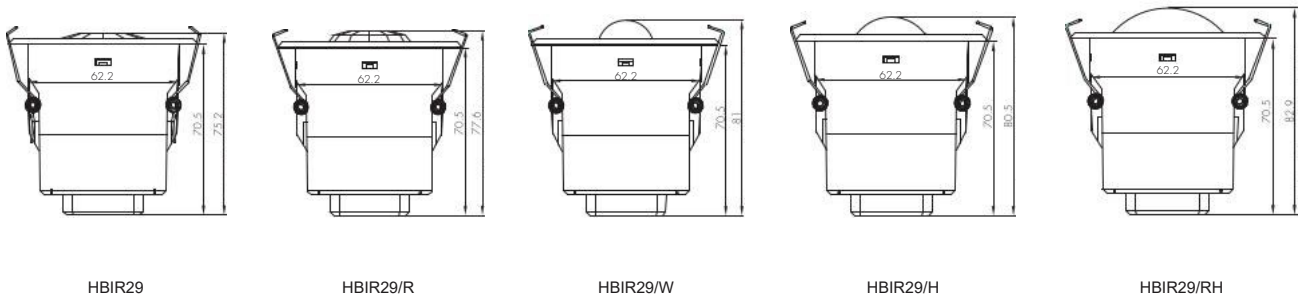
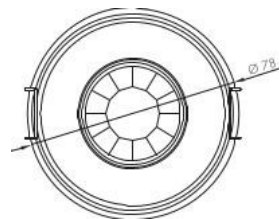

Wiring Diagram

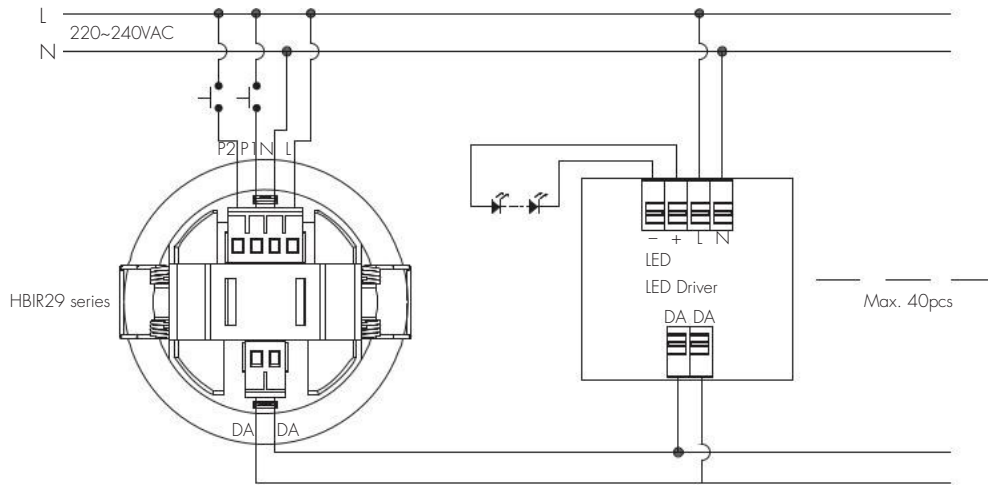

Wire Preparation

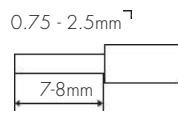

Pluggable screw terminal. It is recommended to make connections to the terminal before fitting to the sensor.

1. 200 metres (total) max. for 1 mm² CSA (Ta = 50°C)
2. 300 metres (total) max. for 1.5 mm² CSA (Ta = 50°C)

Placement Guide and Typical Range

Smart Phone to Device Range



The smart device with the App installed will have a typical range of 10m, but varies from device to device. During commissioning, the installer will need to be in range of the devices when searching for devices to add to the network.

Once the devices have been added to the network via the App, the devices will start communicating within the wireless mesh. This means that once the network is complete, all devices are accessible from the smart device when in a 20m range of a single point.

1. HBIR29 (Low-bay)



HBIR29: Low-bay flat lens detection pattern for **single person** @ $T_a = 20^{\circ}\text{C}$
 (Recommended ceiling mount installation height **2.5m-6m**)

A: Tangential movement	B: Radial movement	Mount height	Tangential (A)	Radial (B)
		2.5m	max 50m ² (Ø = 8m)	max 13m ² (Ø = 4m)
		3m	max 64m ² (Ø = 9m)	max 13m ² (Ø = 4m)
		4m	max 38m ² (Ø = 7m)	max 13m ² (Ø = 4m)
		5m	max 38m ² (Ø = 7m)	max 13m ² (Ø = 4m)
		6m	max 38m ² (Ø = 7m)	max 13m ² (Ø = 4m)

Optional Accessory --- Ceiling/Surface Metal Mount Box: HA09/W, HA09/B, HA09/G



Optional Accessory --- Blind Insert for Blocking Certain Detection Angles

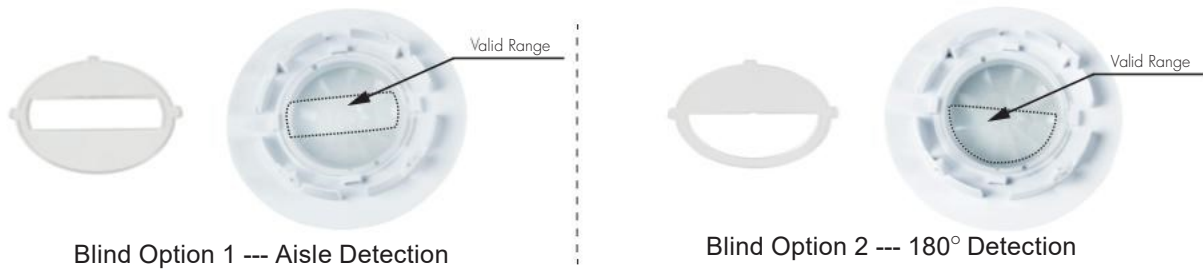

2. HBIR29/R (Reinforced Low-bay)



HBIR29/R: Low-bay convex lens detection pattern for **single person** @ Ta = 20°C

(Recommended ceiling mount installation height **2.5m-6m**)

A: Tangential movement	B: Radial movement	Mount height	Tangential (A)	Radial (B)
		2.5m	max 79m ² (∅ = 10m)	max 20m ² (∅ = 5m)
		3m	max 79m ² (∅ = 10m)	max 20m ² (∅ = 5m)
		4m	max 64m ² (∅ = 9m)	max 20m ² (∅ = 5m)
		5m	max 50m ² (∅ = 8m)	max 20m ² (∅ = 5m)
		6m	max 50m ² (∅ = 8m)	max 20m ² (∅ = 5m)

Optional Accessory --- Ceiling/Surface Metal Mount Box: HA09/W, HA09/B, HA09/G

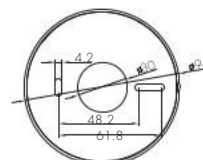
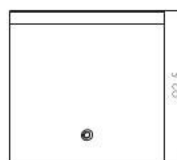

Optional Accessory --- Blind Insert for Blocking Certain Detection Angles



Blind Option 1 --- Aisle Detection



Blind Option 2 --- 180° Detection

3. HBIR29/W (Wide range Low-bay)



HBIR29/W: Low-bay convex lens detection pattern for single person @ Ta = 20°C

(Recommended ceiling mount installation height **2.5m-6m**)

A: Tangential movement	B: Radial movement	Mount height	Tangential (A)	Radial (B)
		2.5m	max 254m ² (Ø = 18m)	max 28m ² (Ø = 6m)
		3m	max 254m ² (Ø = 18m)	max 28m ² (Ø = 6m)
		4m	max 154m ² (Ø = 14m)	max 28m ² (Ø = 6m)
		5m	max 113m ² (Ø = 12m)	max 28m ² (Ø = 6m)
		6m	max 79m ² (Ø = 10m)	max 13m ² (Ø = 4m)

Optional Accessory --- Ceiling/Surface Metal Mount Box: HA09/W, HA09/B, HA09/G

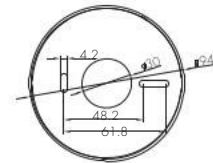
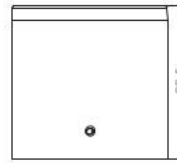

4. HBIR29/H (High-bay)

HBIR29/H: High-bay lens detection pattern for forklift @ Ta = 20°C

(Recommended ceiling mount installation height **10m-15m**)

A: Tangential movement	B: Radial movement	Mount height	Tangential (A)	Radial (B)
		10m	max 380m ² (Ø = 22m)	max 201m ² (Ø = 16m)
		11m	max 452m ² (Ø = 24m)	max 201m ² (Ø = 16m)
		12m	max 452m ² (Ø = 24m)	max 201m ² (Ø = 16m)
		13m	max 452m ² (Ø = 24m)	max 177m ² (Ø = 15m)
		14m	max 452m ² (Ø = 24m)	max 133m ² (Ø = 13m)
		15m	max 452m ² (Ø = 24m)	max 113m ² (Ø = 12m)

HBIR29/H: High-bay lens detection pattern for single person @ Ta = 20°C

(Recommended ceiling mount installation height **2.5m-12m**)

A: Tangential movement	B: Radial movement	Mount height	Tangential (A)	Radial (B)
		2.5m	max 50m ² (Ø = 8m)	max 7m ² (Ø = 3m)
		6m	max 104m ² (Ø = 11.5m)	max 7m ² (Ø = 3m)
		8m	max 154m ² (Ø = 14m)	max 7m ² (Ø = 3m)
		10m	max 227m ² (Ø = 17m)	max 7m ² (Ø = 3m)
		11m	max 269m ² (Ø = 18.5m)	max 7m ² (Ø = 3m)
		12m	max 314m ² (Ø = 20m)	max 7m ² (Ø = 3m)

Optional Accessory -- Ceiling/Surface Metal Mount Box: HA09/W, HA09/B, HA09/G

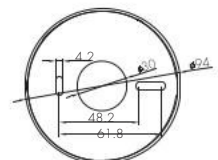
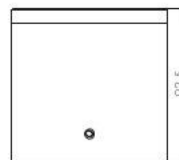

Optional Accessory -- Blind Insert for Blocking Certain Detection Angles



Blind Option 1 --- Aisle Detection



Blind Option 2 --- 180° Detection

Wiring – connecting two or more sensors

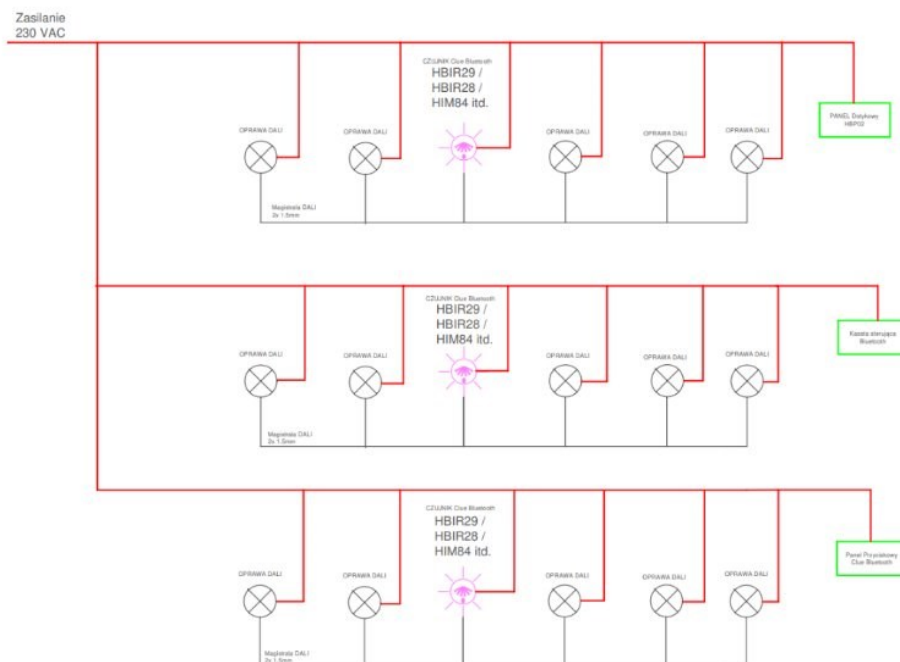

HBIR sensors are powered by a 3x2.5 mm² cable and connected to the DALI bus to lamps within a given zone as shown in the diagram.

REMARK! Do not connect 2 or more sensors together via the DALI bus – this can lead to incorrect operation or even damage to the sensor.

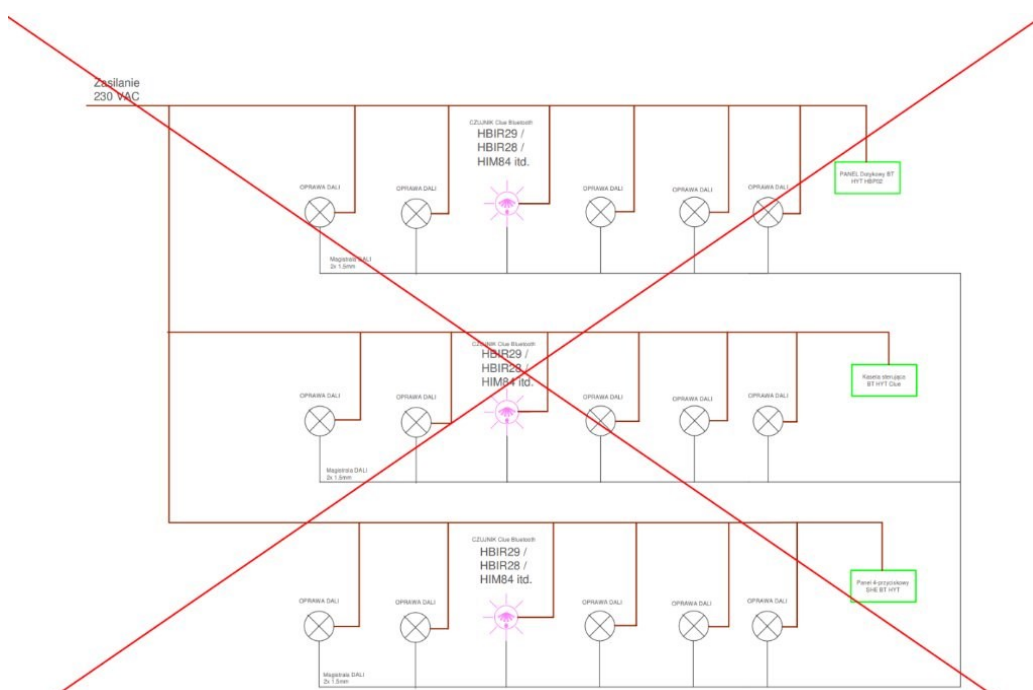

Opcjonalne wyposażenie – Puszka do montażu sufitowego/powierzchniowego: TAKACHI IP67



Kod producenta	Wymiary zewnętrzne			Wymiary wewnętrzne			Kolor puszki	Masa [g]
	S	W	G	s	w	g		
SPCM13 1313G	125	125	125	114.5	110.5	90	RAL7035	401

Small silicon water-proof gasket dimension(size:mm)

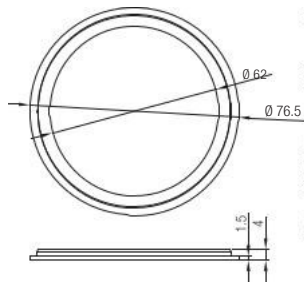

Big silicon water-proof gasket dimension(size:mm)

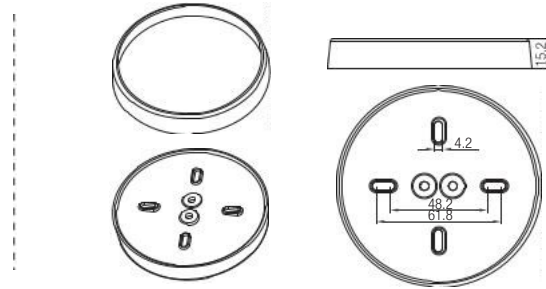

Additional Information / Documents

1. To learn more about detailed product features/functions, please refer to [www.hytronik.com/download ->knowledge ->Introduction of App Scenes and Product Functions](http://www.hytronik.com/download->knowledge->Introduction%20of%20App%20Scenes%20and%20Product%20Functions)
2. Regarding precautions for Bluetooth product installation and operation, please kindly refer to [www.hytronik.com/download ->knowledge ->Bluetooth Products - Precautions for Product Installation and Operation](http://www.hytronik.com/download->knowledge->Bluetooth%20Products%20-%20Precautions%20for%20Product%20Installation%20and%20Operation)
3. Regarding precautions for PIR Sensors installation and operation, please kindly refer to [www.hytronik.com/download ->knowledge ->PIR Sensors - Precautions for Product Installation and Operation](http://www.hytronik.com/download->knowledge->PIR%20Sensors%20-%20Precautions%20for%20Product%20Installation%20and%20Operation)
4. Data sheet is subject to change without notice. Please always refer to the most recent release on [www.hytronik.com/products/bluetooth technology ->Bluetooth Sensors](http://www.hytronik.com/products/bluetooth%20technology->Bluetooth%20Sensors)
5. Regarding Hytronik standard guarantee policy, please refer to [www.hytronik.com/download ->knowledge ->Hytronik Standard Guarantee Policy](http://www.hytronik.com/download->knowledge->Hytronik%20Standard%20Guarantee%20Policy)

Product Description

HIR23/D2 stand-alone PIR & daylight sensors have been certified as DALI-2 input device with main purpose to incorporate into DALI-2 application controller/master. It is ideal for typical indoor applications such as office, classroom, healthcare and other commercial areas.



HIR23/D2/W

Hardware Features

-  2-in-1: PIR motion sensor + Daylight sensor
-  IP20/IP65 ceiling/surface mount box available as accessory
-  Various PIR lens and blind inserts options
-  User-friendly design for installation
-  High bay version available (up to 1.5m in height)
-  5-year warranty
-  Compliant to standard IEC62386_101, 103, 303, 304

Technical Specifications

Sensor Data	
Sensor Model	PIR detection
HIR23/D2/W	Installation Height : 6m Detection Range(Ø) : 18m
Lux reading range	< 1000 lux
Detection angle	360°

Input & Output Characteristics	
Operating voltage	9.5~22.5VDC
Consumption DALI BUS current	Max. 10 mA(no LED) Max. 12 mA(with LED)
Identify device	Red LED flashes 1.5S
Warming-up	5s

Safety & EMC	
EMC standard (EMC)	EN55015, EN61000, EN61547
DALI	IEC60386-101, 103, 303, 304
RED	EN300328, EN301489-1/-17
Certification	CE, REACH, UKCA, RCM, ROHS compliance

Environment	
Operation temperature	Ta: -20°C ~ +50°C
IP rating	IP20

Mechanical Structure & Dimensions

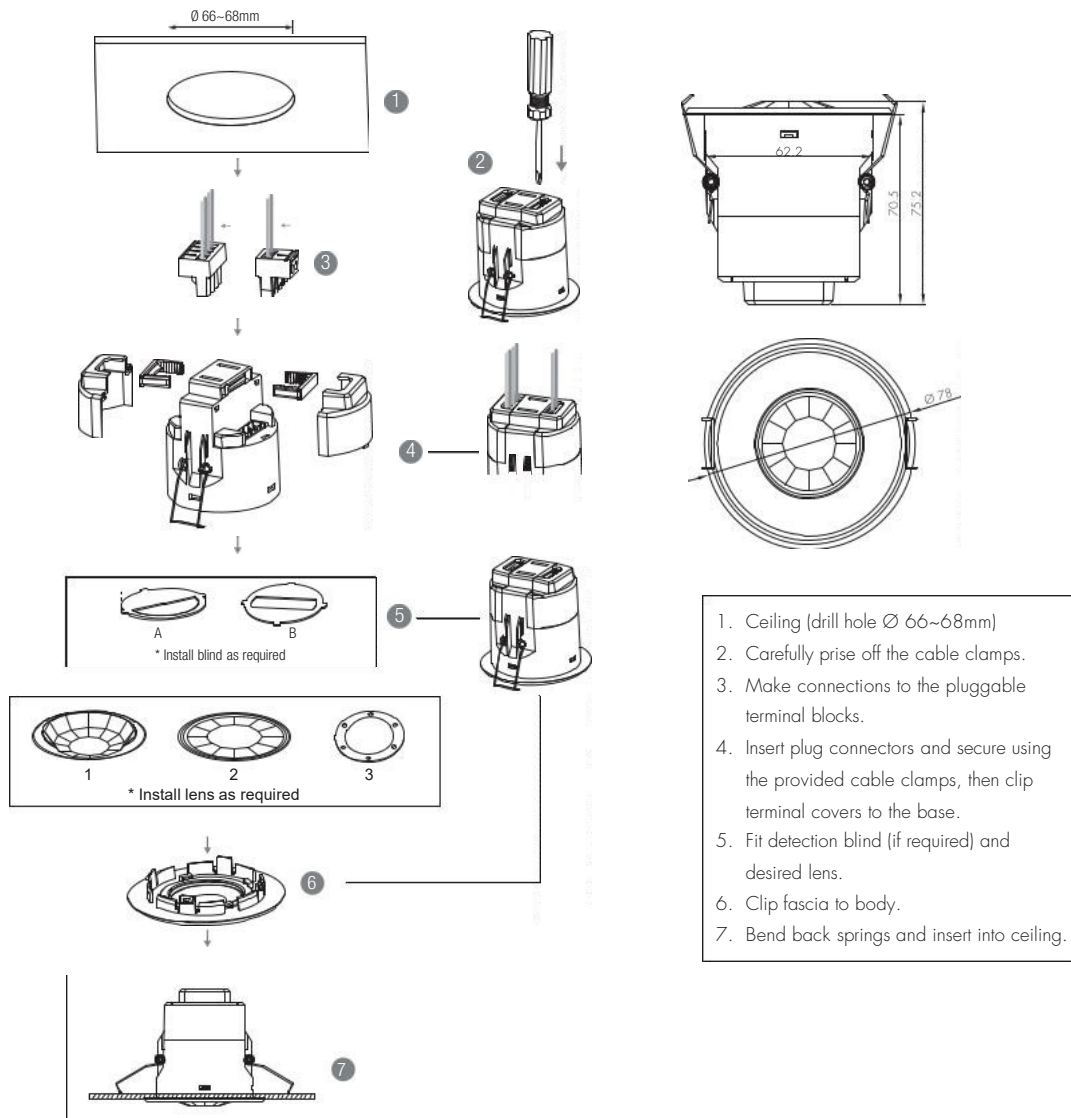

Wire Preparation

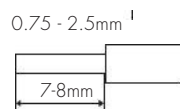

Pluggable screw terminal. It is recommended to make connections to the terminal before fitting to the sensor.

3. HIR23/D2/W (Wide range Low-bay)



HIR23/D2/W: Low-bay convex lens detection pattern for **single person** @ $T_a = 20^\circ\text{C}$

(Recommended ceiling mount installation height **2.5m-6m**)

A: Tangential movement	B: Radial movement	Mount height	Tangential (A)	Radial (B)
		2.5m	max 254m ² (Ø = 18m)	max 28m ² (Ø = 6m)
		3m	max 254m ² (Ø = 18m)	max 28m ² (Ø = 6m)
		4m	max 154m ² (Ø = 14m)	max 28m ² (Ø = 6m)
		5m	max 113m ² (Ø = 12m)	max 28m ² (Ø = 6m)
		6m	max 79m ² (Ø = 10m)	max 13m ² (Ø = 4m)

Optional Accessory --- Ceiling/Surface Mount Box: HA03

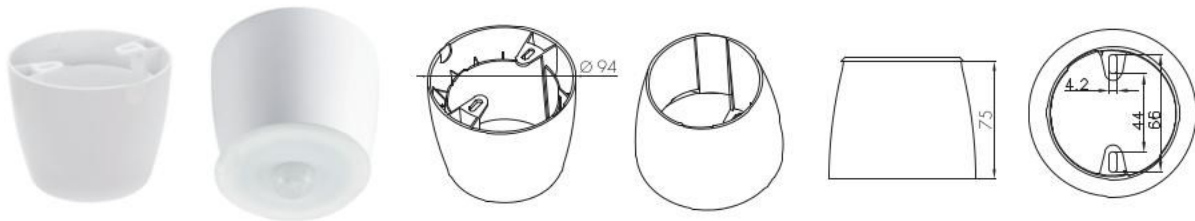

Wiring Diagram

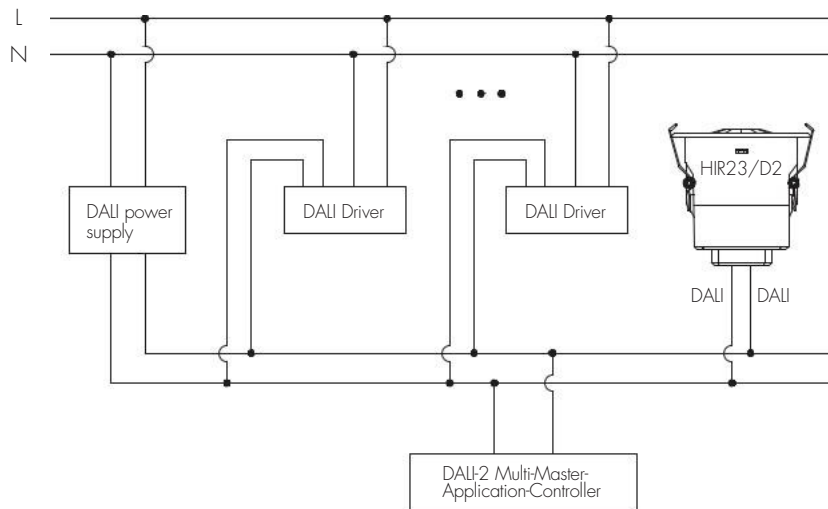

Note: HIR23/D2 has been used as DALI-2 input device to only report DALI instance(light sensor instance and motion sensor instance) to DALI-2 application controller, who is the "main brain" to process the data communication between input devices and the control gear and assign different function.

Additional Information / Documents

1. Regarding precautions for PIR Sensors installation and operation, please kindly refer to [www.hytronik.com/download ->knowledge ->PIR Sensors - Precautions for Product Installation and Operation](http://www.hytronik.com/download->knowledge->PIR%20Sensors%20-%20Precautions%20for%20Product%20Installation%20and%20Operation)
2. Data sheet is subject to change without notice. Please always refer to the most recent release on [www.hytronik.com/products/Motion Sensors ->Stand-alone Sensors](http://www.hytronik.com/products/Motion%20Sensors->Stand-alone%20Sensors)
3. Regarding Hytronik standard guarantee policy, please refer to [www.hytronik.com/download ->knowledge ->Hytronik Standard Guarantee Policy](http://www.hytronik.com/download->knowledge->Hytronik%20Standard%20Guarantee%20Policy)

Flush Mount PIR Motion Sensor



624407 (HIR28)

Low-bay

LENA
LIGHTING

CE emc CB IP20

Applications

Office, classroom and commercial interior spaces where on/off control is required.

- Office / Commercial Lighting
- Classrooms
- Stairwells / Corridors



HIR28

HIR28 with on/off relay control

Designed with a low profile for aesthetically demanding architectural projects providing a high quality sensor for simple on/off occupancy control or providing semi-automatic (absence detection) control.

An intelligent photocell is also included to prevent switching of the lights when natural daylight is available

Set-up of the sensor is carried out using a remote control handset with program memory allowing one-key commissioning where common settings are used for multiple devices.

Features



Store settings in the remote for easy commissioning when programming multiple sensors.



Intelligent photocell - lights and sensors only operate when needed, natural light has priority.



Zero crossing detection to reduce in-rush current and maximise relay life.



5 Year, 50,000hr Warranty

Technical Data

Input Characteristics

Model No.	HIR28
Mains voltage	220~240VAC 50/60Hz
Stand-by power	<1W
Load ratings:	
Capacitive	400W
Resistive	800W
Warming-up	20s

Safety and EMC

EMC standard (EMC)	EN55015, EN61000
Safety standard (LVD)	EN60669-1, EN60669-2-1
Certification	Semko, CB, CE, EMC, LVD, RCM

Sensor Data

Model No.	HIR28
Sensor Model	PIR detection
Detection range (Max.)* HIR28	Installation Height : 6m Detection Range(Ø) : 9m
Detection range (Max.)* HIR28/R	Installation Height : 6m Detection Range(Ø) : 10m
Detection range (Max.)* HIR28/H	Installation height: 1.5m (forklift) 1.2m (person) Detection range (Ø): 24m
Detection range (Max.)* HIR28/RH	Installation height: 1.5m (forklift) 1.2m (person) Detection range (Ø): 40m
Detection angle	360°

* For more details of detection range, please refer to "detection pattern" section.

Environment

Operation temperature	Ta: -20°C ~ +50°C
IP rating	IP20

Mechanical Structure

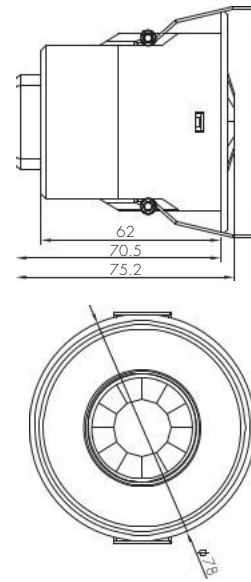
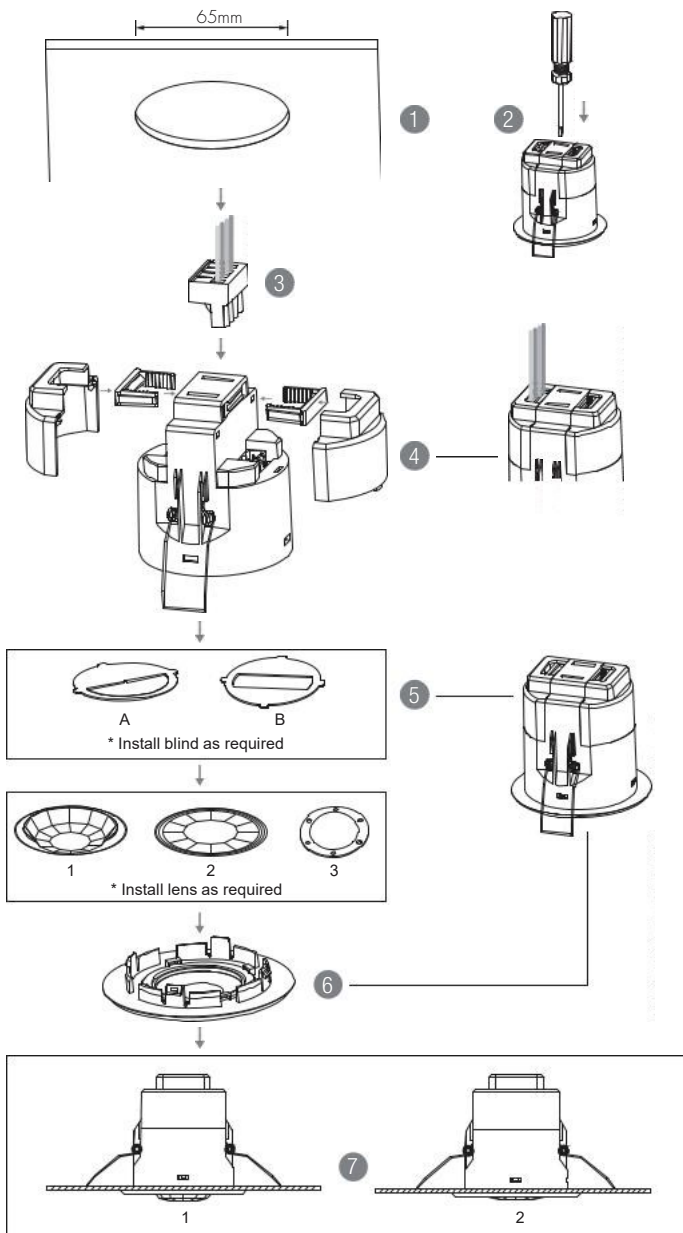

1. Ceiling (drill hole 65mm)
2. Carefully prise off the cable clamps.
3. Make connections to the pluggable terminal blocks.
4. Insert plug connectors and secure using the provided cable clamps, then clip terminal covers to the base.
5. Fit detection blind (if required) and desired lens.
6. Clip fascia to body.
7. Bend back springs and insert into ceiling.

Note: We recommend the mounting distance between sensor to sensor should be more than 2m to prevent sensors from false-triggering.

Wire Preparation

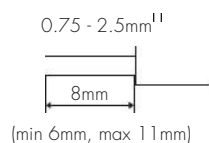

Pluggable screw terminal. It is recommended to make connections to the terminal before fitting to the sensor.

Wiring Diagram

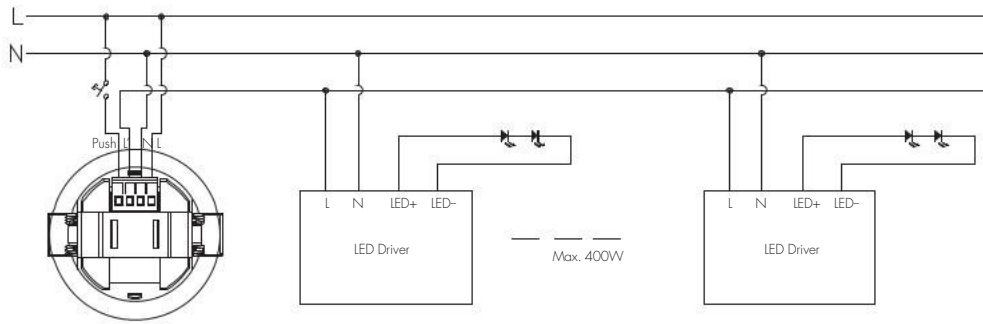

Detection Pattern & Optional Accessories

1. HIR28 (Low-bay)

HIR28: Low-bay flat lens detection pattern for single person @ Ta = 20°C

(Recommended ceiling mount installation height 2.5m-6m)

	Mount height	Tangential (A)	Radial (B)
A: Tangential movement	2.5m	max 50m ² (Ø = 8m)	max 13m ² (Ø = 4m)
B: Radial movement	3m	max 64m ² (Ø = 9m)	max 13m ² (Ø = 4m)
	4m	max 38m ² (Ø = 7m)	max 13m ² (Ø = 4m)
	5m	max 38m ² (Ø = 7m)	max 13m ² (Ø = 4m)
	6m	max 38m ² (Ø = 7m)	max 13m ² (Ø = 4m)

Optional Accessory --- Ceiling/Surface Mount Box: HA03

Optional Accessory --- Blind Insert for Blocking Certain Detection Angles

Blind Option 1 --- Aisle Detection

Blind Option 2 --- 180° Detection

1 On/ off Control

This sensor is a motion switch, which turns on the light upon detection of motion, and turns off after a pre-selected hold-time when there is no movement. A daylight sensor is also built in to prevent the light from switching on when there is sufficient natural light.

2 Intelligent Photocell (daylight detection prior to motion detection)

The built-in photocell will also automatically turn off the light when the ambient natural light exceeds the programmed lux level for more than 5min, regardless of whether motion is detected or not.



With sufficient natural light, the light does not switch on when presence is detected.



With insufficient natural light, the sensor switches on the light automatically when presence is detected.



The sensor switches off the light when natural light is sufficient, even with presence.

3 Manual Override

With the help of push-switch, this sensor can be over-riden by the end-user to manually switch on/off the light, which makes the product more user-friendly and offers more options to fit some extra-ordinary demands:

* Short Push (< 1 s): on/off function;

On → Off: the light turns off immediately and cannot be triggered ON by motion until the expiration of pre-set hold-time. After this period, the sensor goes back to normal sensor mode.

Off → On: the light turns on and goes to sensor mode, no matter if ambient Lux level exceeds the daylight threshold or not.

Note: if end-user do not want this manual override function, just leave the "push" terminal unconnected to any wire.

4 Semi-auto Mode (Absence Detection)

It is easy to forget to switch off the light, in office, corridor, even at home. And in many other cases, people do not want to have a sensor to switch on the light automatically, for example, when people just quickly pass-by, there is no need to have the light on. The solution is to apply this "absence detector": motion sensor is employed, but only activated on the manual press of the push-switch, the light keeps being ON in the presence, and switches off in the long absence.

Note: end-user can choose either function 3 or function 4 for application. Default function is manual override.

5 Zero-cross Relay Operation

Designed in the software, sensor switches on/off the load right at the zero-cross point, to ensure that the in-rush current is minimised, enabling the maximum lifetime of the relay.

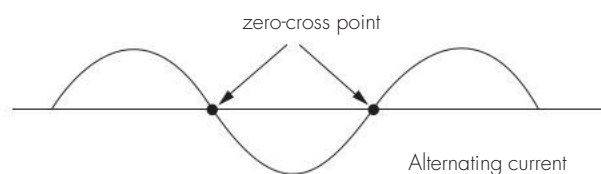

624193 | WSE0010 | 624506 | 625404 (HBIR29)























One DALI output









Product Description

HBIR29 series are Bluetooth PIR standalone motion sensors with one DALI channel output (80mA DALI power supply built in), which can control up to 40 LED drivers. It is ideal for typical indoor applications such as office, classroom, healthcare and other commercial areas. With Bluetooth wireless mesh networking, it makes communication between luminaires much easier without time-consuming hardwiring, which eventually saves costs for projects (especially for retrofit upgrade projects!). Meanwhile, simple device setup and commissioning can be done via Lena Lighting Clue app.











App Features

-  Quick setup mode & advanced setup mode
-  Web app/platform for project deployment & data analysis
-  Koolmesh Pro app on iPad for on-site configuration
-  Floorplan feature to simplify project planning
-  coming soon
-  One-key device replacement
-  Device social relations check
-  Staircase function (primary & secondary)
-  Remote control via gateway support HBGW01
-  Heat map
-  Dynamic daylight harvest auto-adaptation
-  Grouping luminaires via mesh network
-  Scenes
-  Dusk/Dawn photocell (Twilight function)
-  Tri-level control
-  Daylight harvest
-  Circadian rhythm (Human centric lighting)
-  Push switch configuration
-  Detailed motion sensor settings
-  Schedule
-  Astro timer (sunrise and sunset)
-  Power-on status (memory against power loss)
-  Offline commissioning

-  Bulk commissioning (copy and paste settings)
-  Different permission levels via authority management
-  Network sharing via QR code or keycode
-  Interoperability with Hytronik Bluetooth product portfolio
-  Compatible with EnOcean BLE switches
-  Internet-of-Things (IoT) featured
-  Device firmware update over-the-air (OTA)
-  Continuous development in progress...

Hardware Features

-  80mA DALI broadcast output
-  Support to control DT8 LED drivers
-  2 Push inputs for flexible manual control
-  IP20/IP54 Ceiling/Surface mount box available as accessory
-  Two types of blind inserts / blanking plates
-  User-friendly design for installation
-  High bay version available (up to 1.5m in height)
-  5-year warranty



Fully support EnOcean self-powered switch module PTM215B (HBES01/W & HBES01/B)

Smartphone app for both
iOS & Android platform

Web app/platform:
www.iot.koolmesh.com

Technical Specifications

Bluetooth Transceiver	
Operation frequency	2.4 GHz - 2.483 GHz
Transmission power	4 dBm
Range (Typical indoor)	10~30m
Protocol	5.0 SIG Mesh

Input & Output Characteristics	
Operating voltage	220~240VAC 50/60Hz
Stand-by power	< 1W
Switched power	Max. 40 devices, 80mA
Warming-up	20s

Sensor Data	
Sensor Model	PIR detection
HBIR29	Installation Height : 6m Detection Range(Ø) : 9m
HBIR29/R	Installation Height : 6m Detection Range(Ø) : 10m
HBIR29/W	Installation Height : 6m Detection Range(Ø) : 18m
HBIR29/H	Installation height: 1.5m (forklift) 12m (person) Detection range (Ø): 24m
Detection angle	360°

Safety & EMC	
EMC standard (EMC)	EN55015, EN61000, EN61547
Safety standard (LVD)	EN60669-1, EN60669-2-1 AS/NZS60669-1/-2-1
RED	EN300328, EN301489-1/-17
Certification	CB, CE, EMC, RED, RCM

Environment	
Operation temperature	Ta: -20°C ~ +50°C
IP rating	IP20

* For more details of detection range, please refer to "detection pattern" section.

Mechanical Structure & Dimensions

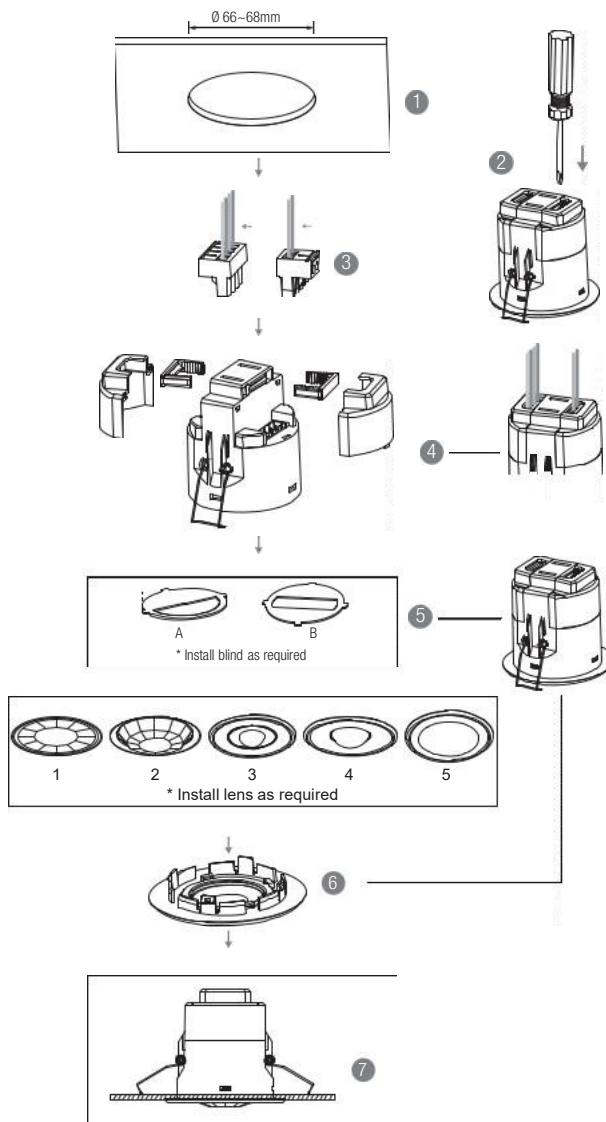

1. Ceiling (drill hole \varnothing 66~68mm)
2. Carefully prise off the cable clamps.
3. Make connections to the pluggable terminal blocks.
4. Insert plug connectors and secure using the provided cable clamps, then clip terminal covers to the base.
5. Fit detection blind (if required) and desired lens.
6. Clip fascia to body.
7. Bend back springs and insert into ceiling.

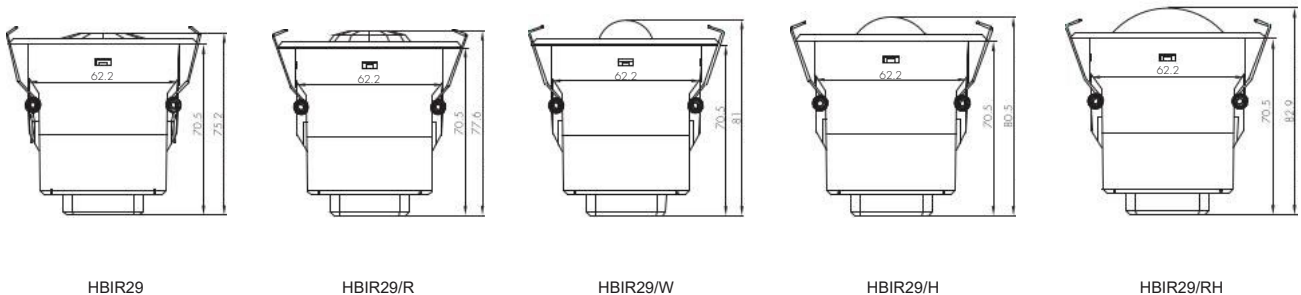
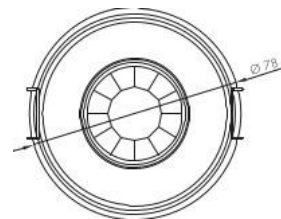

Wiring Diagram

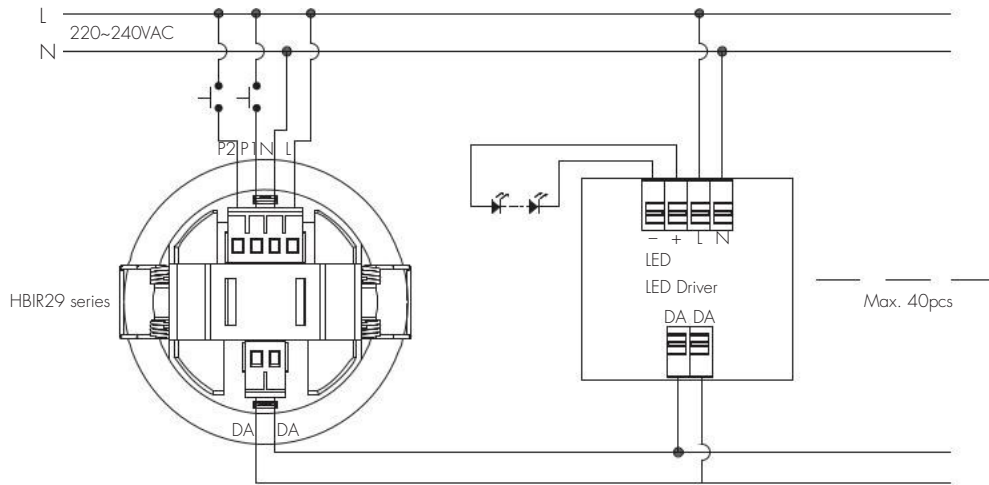

Wire Preparation

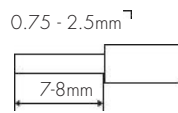

Pluggable screw terminal. It is recommended to make connections to the terminal before fitting to the sensor.

1. 200 metres (total) max. for 1mm² CSA (Ta = 50°C)
2. 300 metres (total) max. for 1.5mm² CSA (Ta = 50°C)

Placement Guide and Typical Range

Smart Phone to Device Range



The smart device with the App installed will have a typical range of 10m, but varies from device to device. During commissioning, the installer will need to be in range of the devices when searching for devices to add to the network.

Once the devices have been added to the network via the App, the devices will start communicating within the wireless mesh. This means that once the network is complete, all devices are accessible from the smart device when in a 20m range of a single point.

1. HBIR29 (Low-bay)



HBIR29: Low-bay flat lens detection pattern for **single person** @ $T_a = 20^{\circ}\text{C}$

(Recommended ceiling mount installation height **2.5m-6m**)

A: Tangential movement	B: Radial movement	Mount height	Tangential (A)	Radial (B)
		2.5m	max 50m ² (Ø = 8m)	max 13m ² (Ø = 4m)
		3m	max 64m ² (Ø = 9m)	max 13m ² (Ø = 4m)
		4m	max 38m ² (Ø = 7m)	max 13m ² (Ø = 4m)
		5m	max 38m ² (Ø = 7m)	max 13m ² (Ø = 4m)
		6m	max 38m ² (Ø = 7m)	max 13m ² (Ø = 4m)

Optional Accessory --- Ceiling/Surface Metal Mount Box: HA09/W, HA09/B, HA09/G



Optional Accessory --- Blind Insert for Blocking Certain Detection Angles

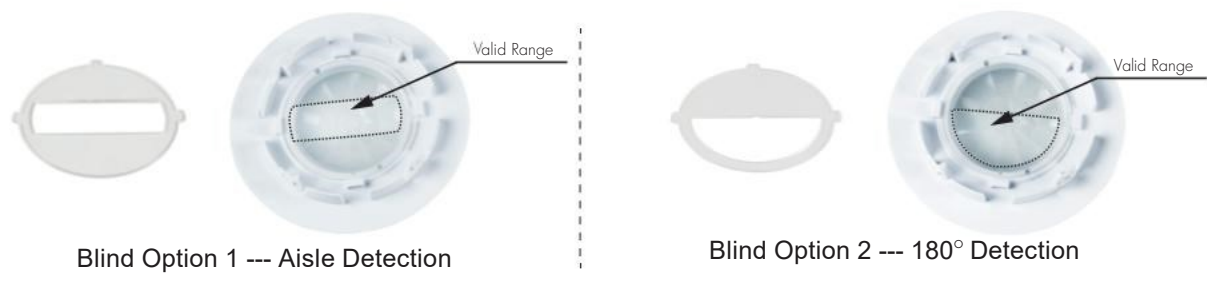

2. HBIR29/R (Reinforced Low-bay)



HBIR29/R: Low-bay convex lens detection pattern for **single person** @ Ta = 20°C

(Recommended ceiling mount installation height **2.5m-6m**)

A: Tangential movement	B: Radial movement	Mount height	Tangential (A)	Radial (B)
		2.5m	max 79m ² (∅ = 10m)	max 20m ² (∅ = 5m)
		3m	max 79m ² (∅ = 10m)	max 20m ² (∅ = 5m)
		4m	max 64m ² (∅ = 9m)	max 20m ² (∅ = 5m)
		5m	max 50m ² (∅ = 8m)	max 20m ² (∅ = 5m)
		6m	max 50m ² (∅ = 8m)	max 20m ² (∅ = 5m)

Optional Accessory --- Ceiling/Surface Metal Mount Box: HA09/W, HA09/B, HA09/G

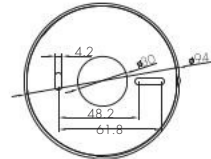
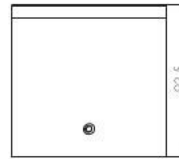

Optional Accessory --- Blind Insert for Blocking Certain Detection Angles



Blind Option 1 --- Aisle Detection



Blind Option 2 --- 180° Detection

3. HBIR29/W (Wide range Low-bay)



HBIR29/W: Low-bay convex lens detection pattern for **single person** @ $T_a = 20^\circ\text{C}$

(Recommended ceiling mount installation height **2.5m-6m**)

A: Tangential movement	B: Radial movement	Mount height	Tangential (A)	Radial (B)
		2.5m	max 254m ² (Ø = 18m)	max 28m ² (Ø = 6m)
		3m	max 254m ² (Ø = 18m)	max 28m ² (Ø = 6m)
		4m	max 154m ² (Ø = 14m)	max 28m ² (Ø = 6m)
		5m	max 113m ² (Ø = 12m)	max 28m ² (Ø = 6m)
		6m	max 79m ² (Ø = 10m)	max 13m ² (Ø = 4m)

Optional Accessory --- Ceiling/Surface Metal Mount Box: HA09/W, HA09/B, HA09/G

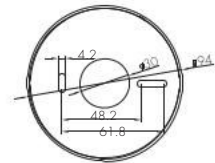
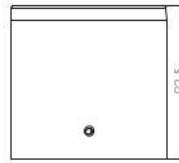

4. HBIR29/H (High-bay)

HBIR29/H: High-bay lens detection pattern for forklift @ Ta = 20°C

(Recommended ceiling mount installation height **10m-15m**)

A: Tangential movement	B: Radial movement	Mount height	Tangential (A)	Radial (B)
		10m	max 380m ² (Ø = 22m)	max 201m ² (Ø = 16m)
		11m	max 452m ² (Ø = 24m)	max 201m ² (Ø = 16m)
		12m	max 452m ² (Ø = 24m)	max 201m ² (Ø = 16m)
		13m	max 452m ² (Ø = 24m)	max 177m ² (Ø = 15m)
		14m	max 452m ² (Ø = 24m)	max 133m ² (Ø = 13m)
		15m	max 452m ² (Ø = 24m)	max 113m ² (Ø = 12m)

HBIR29/H: High-bay lens detection pattern for single person @ Ta = 20°C

(Recommended ceiling mount installation height **2.5m-12m**)

A: Tangential movement	B: Radial movement	Mount height	Tangential (A)	Radial (B)
		2.5m	max 50m ² (Ø = 8m)	max 7m ² (Ø = 3m)
		6m	max 104m ² (Ø = 11.5m)	max 7m ² (Ø = 3m)
		8m	max 154m ² (Ø = 14m)	max 7m ² (Ø = 3m)
		10m	max 227m ² (Ø = 17m)	max 7m ² (Ø = 3m)
		11m	max 269m ² (Ø = 18.5m)	max 7m ² (Ø = 3m)
		12m	max 314m ² (Ø = 20m)	max 7m ² (Ø = 3m)

Optional Accessory -- Ceiling/Surface Metal Mount Box: HA09/W, HA09/B, HA09/G

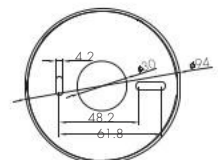
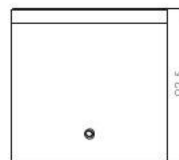

Optional Accessory -- Blind Insert for Blocking Certain Detection Angles

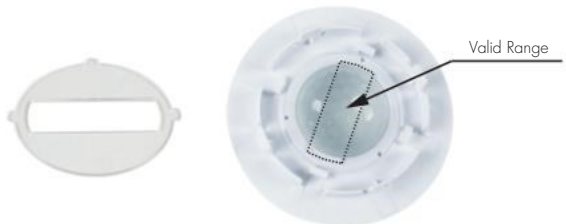

Blind Option 1 --- Aisle Detection



Blind Option 2 --- 180° Detection

Small silicon water-proof gasket dimension(size:mm)

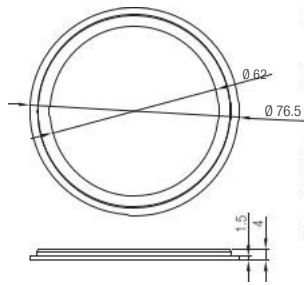

Big silicon water-proof gasket dimension(size:mm)

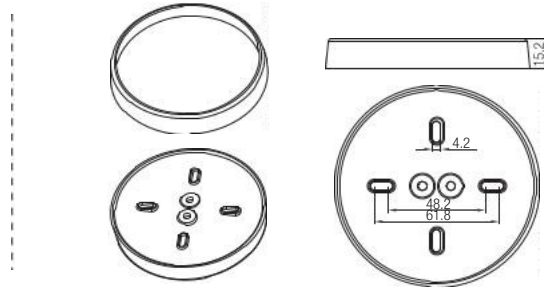

Additional Information / Documents

1. To learn more about detailed product features/functions, please refer to [www.hytronik.com/download ->knowledge ->Introduction of App Scenes and Product Functions](http://www.hytronik.com/download->knowledge->Introduction%20of%20App%20Scenes%20and%20Product%20Functions)
2. Regarding precautions for Bluetooth product installation and operation, please kindly refer to [www.hytronik.com/download ->knowledge ->Bluetooth Products - Precautions for Product Installation and Operation](http://www.hytronik.com/download->knowledge->Bluetooth%20Products%20-%20Precautions%20for%20Product%20Installation%20and%20Operation)
3. Regarding precautions for PIR Sensors installation and operation, please kindly refer to [www.hytronik.com/download ->knowledge ->PIR Sensors - Precautions for Product Installation and Operation](http://www.hytronik.com/download->knowledge->PIR%20Sensors%20-%20Precautions%20for%20Product%20Installation%20and%20Operation)
4. Data sheet is subject to change without notice. Please always refer to the most recent release on [www.hytronik.com/products/bluetooth technology ->Bluetooth Sensors](http://www.hytronik.com/products/bluetooth%20technology->Bluetooth%20Sensors)
5. Regarding Hytronik standard guarantee policy, please refer to [www.hytronik.com/download ->knowledge ->Hytronik Standard Guarantee Policy](http://www.hytronik.com/download->knowledge->Hytronik%20Standard%20Guarantee%20Policy)

DALI PIR Motion Sensor with HRC-11 Remote Control

WSEL381 (HCD049) (High-bay)
DALI/DALI-2 Bolt-on/Batten-fit PIR Sensor



LENA
LIGHTING

Clue[®]



IP65

Product Description

HCD049 is a DALI high-bay PIR motion sensor, with capability of up to 1.5m installation height. HCD049 has a daylight sensor built-in, and is specifically designed for mounting onto a batten style luminaire. All sensor parameters can be programmed through remote controller HRC-11.

Hardware Features

- 30mA DALI Broadcast output
- IP65
- Fixing washers accessory
- High-bay (up to 1.5m height)
- 5-year warranty, designed for long lifetime up to 50,000 hours
- Daylight Harvest
- Remote controllable



Technical Specifications

Input Characteristics

Model No.	HCD049
Operating voltage	220 ~ 240VAC 50/60Hz
Stand-by power	< 1W
Output	30mA, 12VDC (max. 15 devices)
Warming-up	30s

Safety and EMC

EMC standard (EMC)	EN55015, EN61547 EN61000-3-2/-3-3
Safety standard (LVD)	EN61347-1, EN61347-2-11
Certification	ENEC, CE, EMC, LVD, RCM
RED	EN300328, EN301489-1 EN301489-17

Sensor Data

Model No.	HCD049
Sensor principle	PIR detection
Detection range*	Max installation height: 1.5m (forklift) 1.2m (single person) Max detection range: 1.6m (diameter)
Detection angle	360°

* The detection range is heavily influenced by sensor placement (angle) and different walking paces. It may be reduced under certain conditions.

Environment

Operation temperature	Ta: -20°C ~ +50°C
IP rating	IP65

Mechanical Structure & Dimensions

(unit:mm)

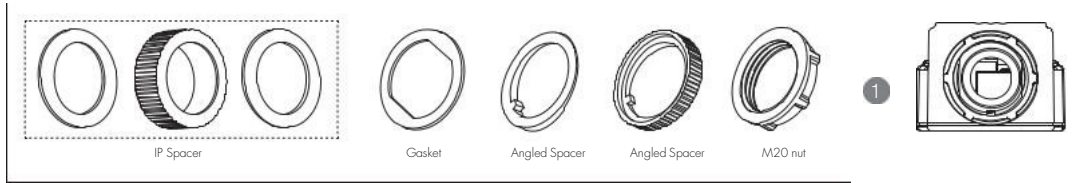
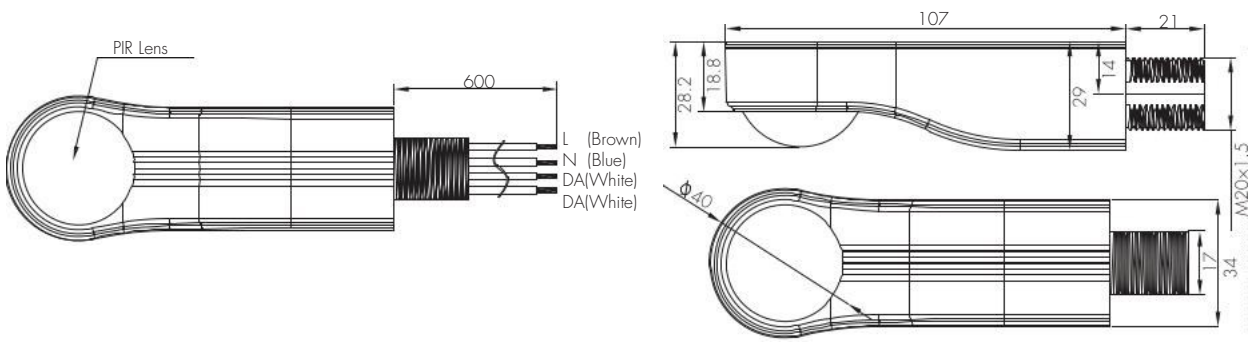

Typical Installation 1

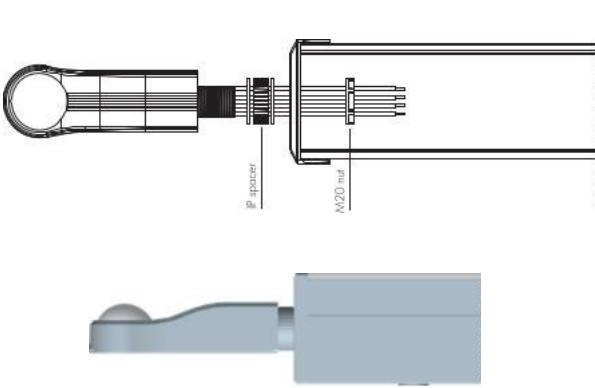

Typical Installation 2

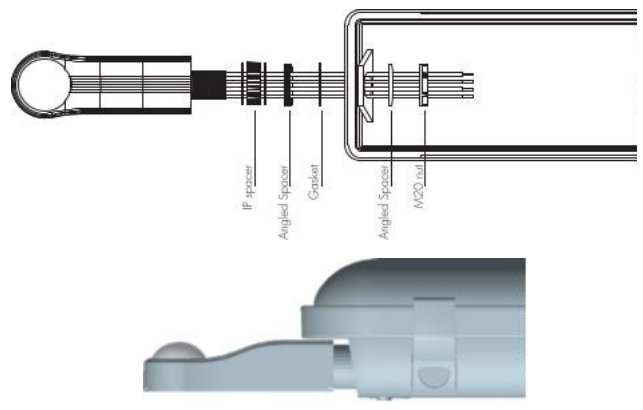

Wiring Diagram

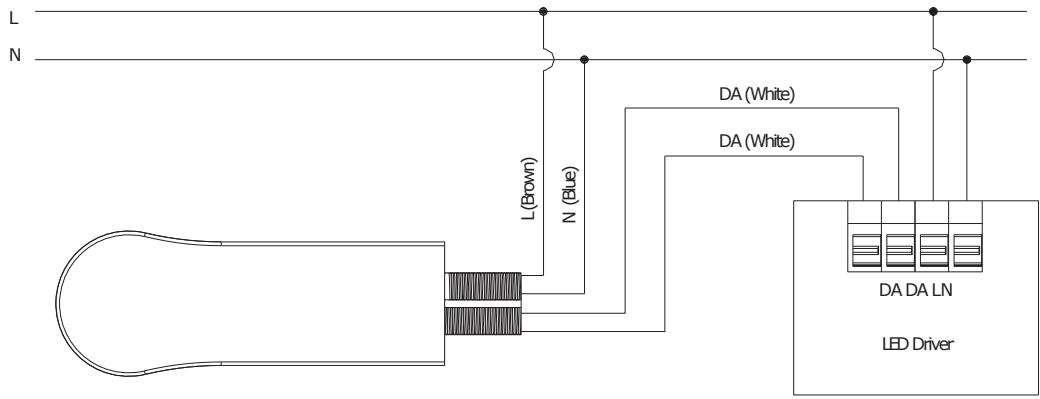

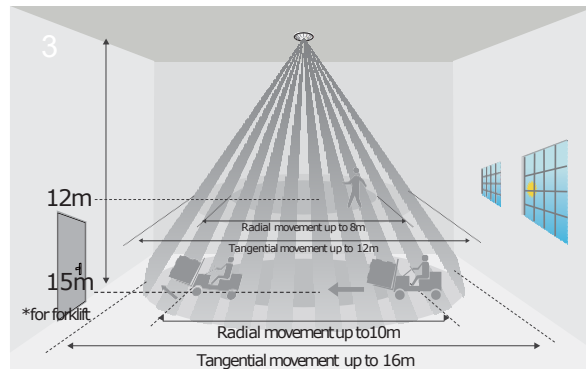

*The detection patterns are based upon 5km/h movement speed.

Additional Information / Documents

1. To learn more about detailed product features/functions, please refer to www.hytronik.com/download ->knowledge ->Introduction of App Scenes and Product Functions
2. Regarding precautions for Bluetooth product installation and operation, please kindly refer to www.hytronik.com/download ->knowledge ->Bluetooth Products -Precautions for Product Installation and Operation
3. Regarding precautions for PIR sensor installation and operation, please kindly refer to www.hytronik.com/download ->knowledge ->PIR Sensors -Precautions for Product Installation and Operation
4. Data sheet is subject to change without notice. Please always refer to the most recent release on www.hytronik.com/products/bluetooth technology ->Bluetooth Sensors
5. Regarding Hytronik standard guarantee policy, please refer to www.hytronik.com/download->knowledge ->Hytronik Standard Guarantee Policy

PRESCONTROL PRO

PASSIVE INFRARED (PIR) PRESENCE SENSOR



TECHNICAL PARAMETERS

Power supply:	230V/50Hz
Rated power:	2000 W Max light bulb ~ (resistive load)
Detection range:	360°
Movement range:	max. 9 metres
Presence detection range:	max. 3 metres
Delay time:	from (10 ± 5) seconds to (40 ± 5) minutes adjustable
LUX	daylight or night light adjustable
illumination level:	
Protection class:	II
Working temperature:	25°C (clean environment)
Application:	Indoor only

PRODUCT CHARACTERISTICS

The presence sensor is a precise device that switches on one luminaire or a group of luminaires based on motion detection or presence detection. Depending on the type of room, it allows for significant energy savings at a low cost of installation.

APPLICATION

Offices, toilets, service points, booths, checkout counters. All locations where detection and automatic activation of devices based on slight movements is needed, e.g. hand or head movements in a sitting or standing position. In such situations, ordinary motion sensors will not work, because they require a definite movement from point A to point B (e.g. crossing a corridor). Prescontrol Pro presence sensor switches on or off a luminaire or a group of luminaires and other devices (e.g. ventilation, air conditioning). The sensor can be connected directly or via a contactor or relay. The presence sensor can also be used as a precision motion sensor mounted outside the luminaire.

PRESCONTROL PRO

PASSIVE INFRARED (PIR) PRESENCE SENSOR

PRINCIPLE OF OPERATION

The basis for the operation of the passive presence sensor are small temperature changes in the detection fields. The extremely sensitive pyroelectric detector (infrared detector) reacts to the infrared waves emitted by people, even when the person in a sitting position makes a slight movement of his head or hand, e.g. during office work or in the toilet, and this way activates the luminaire. The use of a presence sensor eliminates the inconvenience associated with the use of motion sensors, which in such situations may turn the luminaires off.

OPERATING RANGE

The sensor works within the radius of 360 degrees. The best results are obtained when mounting the device at a height of 2.5 to 3.5 m. The range of motion detection – e.g. of people moving or walking through – is 9 m. The range of presence detection – e.g. detection of small hand or head movements – is 3 m.

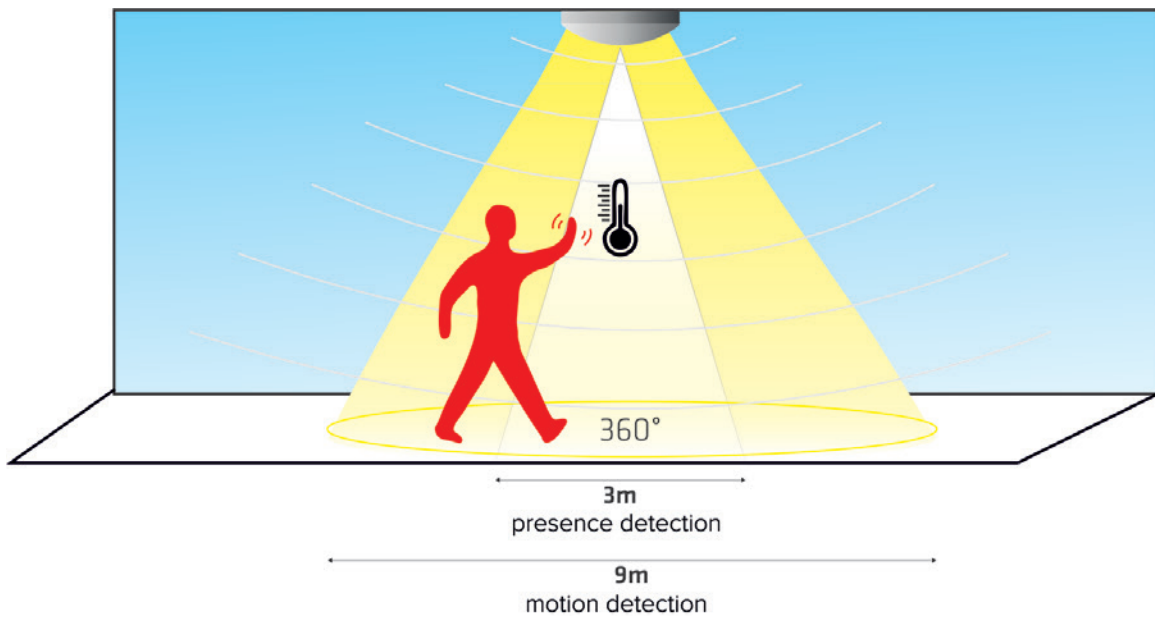

FUNCTIONALITY

The sensor's operating mode can be easily adjusted to individual requirements. The sensor allows to adjust illuminance (day-night identification), length of working time (switch off delay) and effective range of operation (distance from the sensor and detection area).

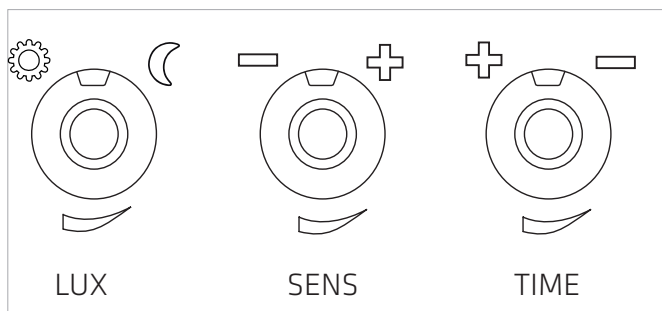

PRESCONTROL PRO

PASSIVE INFRARED (PIR) PRESENCE SENSOR

TECHNICAL DRAWINGS

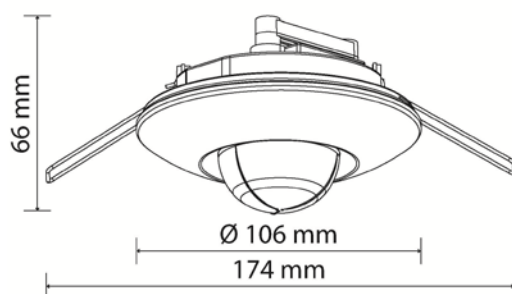

MOUNTING METHOD



surface mounted



flush mounted

TECHNICAL DETAILS



Surface mounting



Flush mounting

INDEX TABLE

index	Name	Remarks
W01162	PRESCONTROL PRO presence sensor	Universal ordering index – both surface and flush mounting – see the instruction.

PRESCONTROL PRO

EASY STANDARD-BASED CONTROL – LOCATION LIST WITH RECOMMENDED CONTROL OPTIONS

REQUIREMENTS FOR THE LIGHTING OF INDOOR WORKPLACES ACCORDING TO PN-EN 12464-1:2011 STANDARD

OFFICES

Ref. no.	Type of area. Application or activity	Specific requirements
5.26.5	Conference and meeting rooms	Lighting control recommended

PUBLIC GATHERING PLACES – RESTAURANTS AND HOTELS

Ref. no.	Type of area. Application or activity	Specific requirements
5.29.6	Conference rooms	Lighting control recommended

EDUCATIONAL ROOMS – EDUCATIONAL BUILDINGS

Ref. no.	Type of area. Application or activity	Specific requirements
5.36.1	Classrooms, self-study rooms	Lighting control recommended
5.36.2	Classrooms for evening classes and adult education	Lighting control recommended
5.36.4	Auditorium, lecture halls	Lighting control recommended in order to accommodate different power requirements (A/V).

HEALTH CARE ROOMS – TREATMENT ROOMS (GENERAL)

Ref. no.	Type of area. Application or activity	Specific requirements
5.45.1	Dialyses	Lighting control recommended
5.45.2	Dermatology	Lighting control recommended

PRESCONTROL PRO

PASSIVE INFRARED (PIR) PRESENCE DETECTOR

SENSOR USER AND INSTALLATION MANUAL

- 1** We are glad you have bought the PIR sensor. The sensor is intended for indoor use only. Please read the manual before installation and keep it for future reference. **IMPORTANT:** Never modify the device, parts cannot be replaced. Not suitable for use with dimmers. Install in accordance with the IEC installation regulations.

THE SENSOR SHOULD BE INSTALLED BY A QUALIFIED ELECTRICIAN.

2 PRESENCE

The PIR sensor has a presence detection range with a radius of 3 metres. The sensor will detect slight movement (head movements, slow walking, etc.) within this range to turn on or maintain the lighting. If you want to achieve the best results, we suggest you take into account the following information:

1. The range of presence detection is 3 metres.
2. We suggest setting the delay time to more than 10 minutes.
3. the PIR sensor must operate at a temperature of about 25°C or lower and in a clean environment (normal temperature)

3 SENSOR LOCATION

When selecting the place of installation, consider the following:

1. The sensor operates with optimum performance at a mounting height of 2.5 to 3.5 m (see Fig. 1)
2. Avoid installation near heat sources such as radiators, air vents, air conditioners that can be a source of signals received by the sensor.
3. Avoid installation in bright lighting conditions, the PIR sensor does not work when the lux control level is set (C position).
4. Avoid installation near sources of strong electromagnetic interference, e.g. near an electric motor or fluorescent lamp power supply.
5. Cable entry holes (min. 4.0 x 5.0 mm), can be opened if necessary.

4 SENSOR INSTALLATION

Before starting any electrical work, make sure that the power is turned off by turning off and removing the appropriate fuse. (See Fig. 2A and Fig. 2B)

A. Ceiling installation (Fig. 2A)

1. Remove the front cover and disassemble the main unit by prying it out with a screwdriver in the places marked with an arrow
2. Unscrew the cable holder, remove the junction box with the terminal block
3. Use the bottom cover to mark the location of the screw holes on the installation surface. Drill through the wall to a depth of about 35 mm, install wall plugs, carefully screw the mounting box with screws.
Be careful to avoid drilling or screwing into hidden electrical wiring.
4. Connect the power cables to the terminal block
5. Install the junction box with the terminal block, install the cable holder.
6. Align and attach the main unit to the bottom cover, and then attach the front cover.

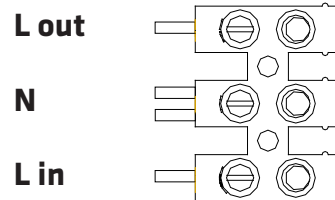
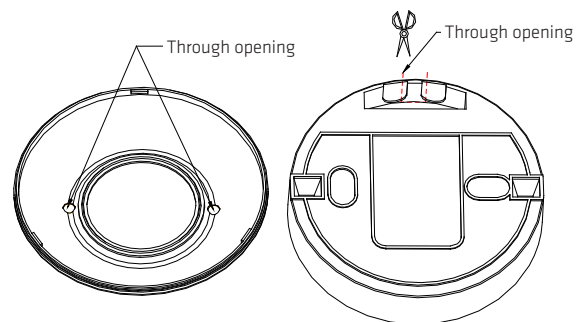
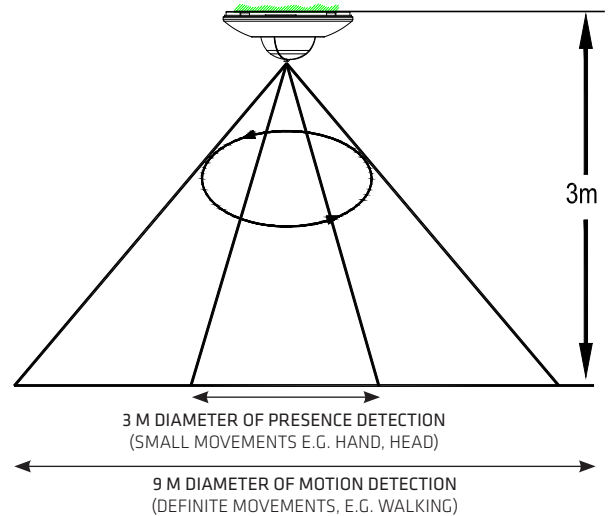

PRESCONTROL PRO

PASSIVE INFRARED (PIR) PRESENCE DETECTOR

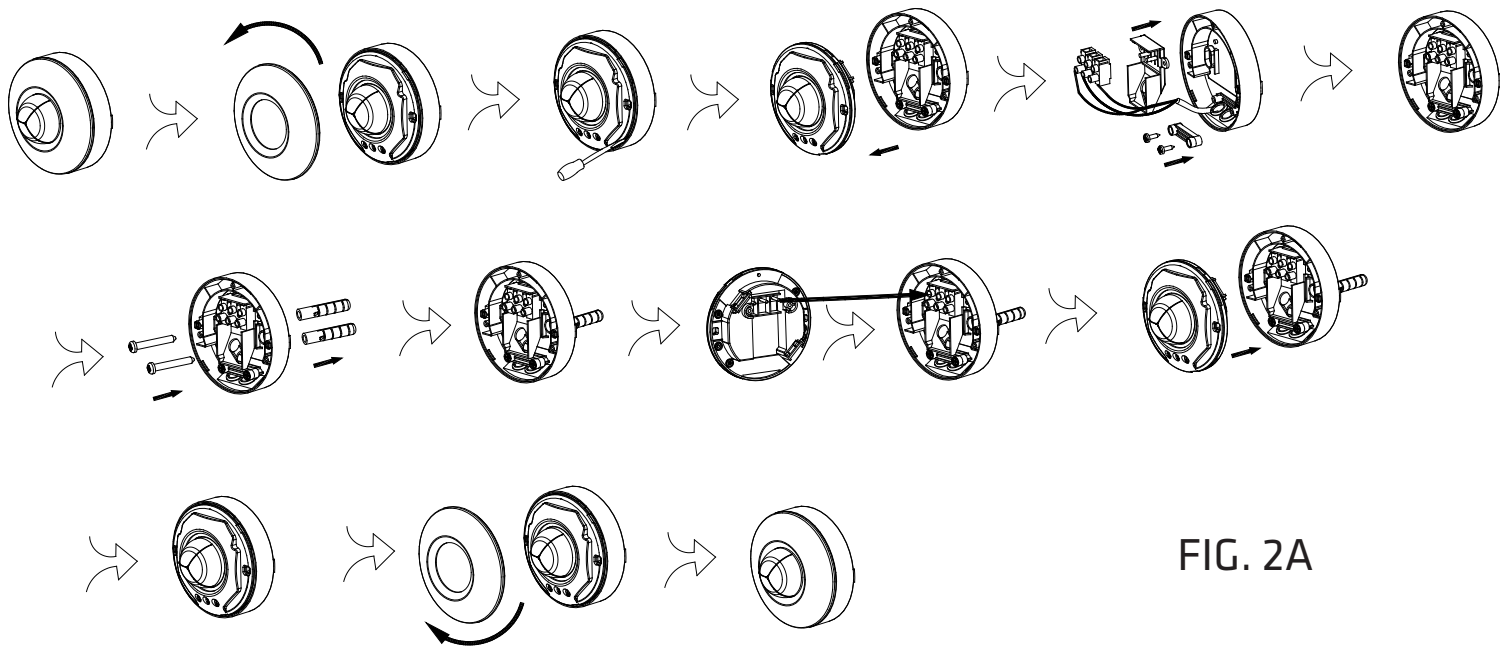

FIG. 2A

B. Recessed mounting (Fig. 2b)

1. Open the spring to position Fig. 2B
 2. Press the spring into the groove and then close the spring
 3. Unscrew the cable holder, remove the junction box with the terminal block.
 4. Connect the power cables to the terminal block
 5. Install the junction box with the terminal block, install the cable holder.
 6. Drill a hole with a diameter of 80 mm in the ceiling
 7. Install the main unit in the hole in the ceiling using springs.
- After completing the installation, you can set the PIR sensor working status

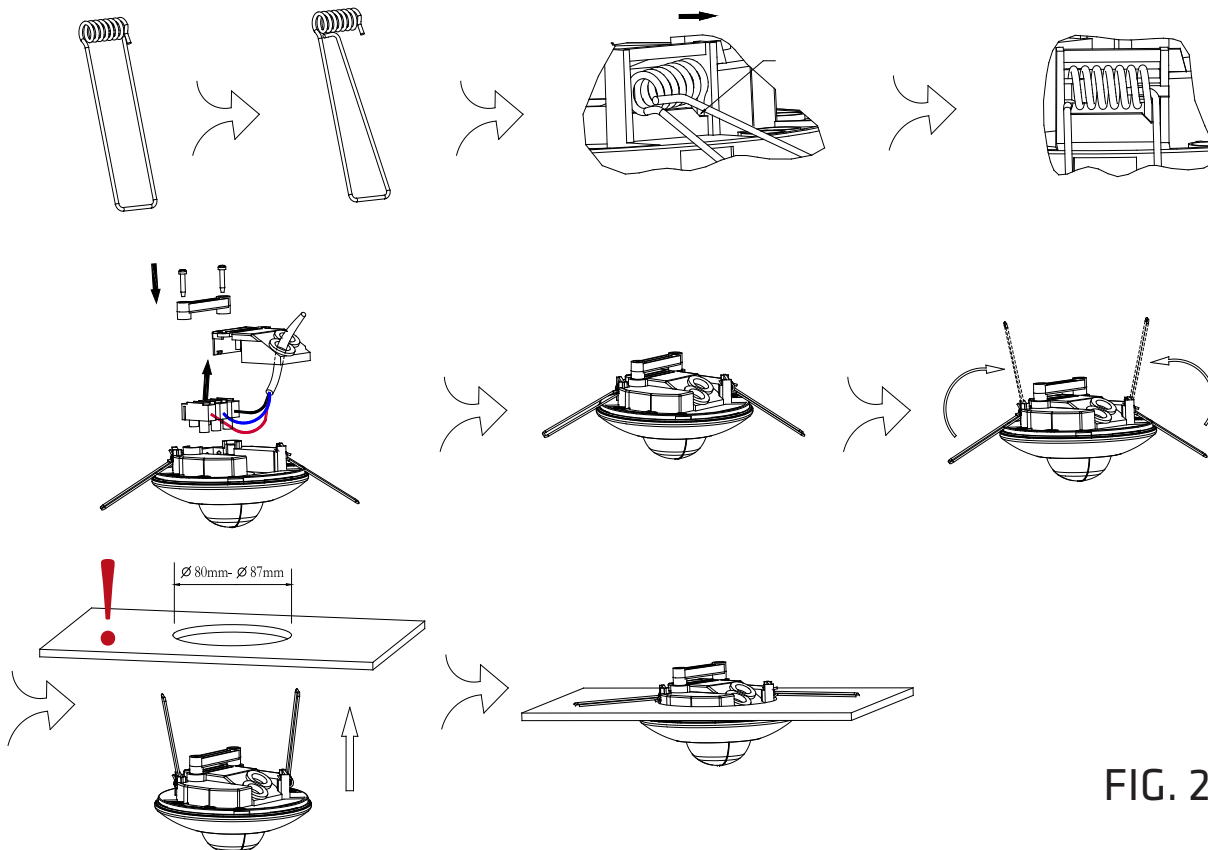

FIG. 2B

PRESCONTROL PRO

PASSIVE INFRARED (PIR) PRESENCE SENSOR

5 LUX BRIGHTNESS LEVEL ADJUSTMENT

The LUX control is a built-in sensor (photocell) that detects light and darkness.

(☀) position – means that the light will be switched on during the day and at night.

(☾) position – means that the light will be switched on only at night.

You can set the device to work at the desired level of light intensity by adjusting the LUX knob

TIME delay adjustment:

Duration means the time the lighting is switched on once activated by the PIR sensor. Duration can be adjusted from (10 ± 5) seconds to (40 ± 5) minutes. Turning the TIME knob from (+) to (-) decreases the delay time.

Note: When the light is switched on by the PIR sensor, any subsequent motion/presence detection will reset the counting of the delay time.

SENS – sensitivity adjustment:

Sensitivity is the maximum distance at which the PIR sensor can be activated by body movement. Turning the SENS knob from (+) to (-) will decrease the sensitivity.

6 PARAMETER ADJUSTMENT

1. Set the LUX knob to the (☾) light position (☾), turn on the power and wait half a minute until the control circuit stabilises. At this stage, make sure the TIME knob is set to the minimum delay time - (-) position. The lighting will turn on and will stay on for about 30 seconds (within 60 seconds).
2. Position the sensor in the desired detection area
3. Use another person to move along the centre of the detection area until the lighting is on.
- 4 Set the delay time to the required level.

To set the level of light intensity at which the sensor will automatically turn on the lighting at night, turn the LUX knob from daylight (☀) to night (☾). If you need to switch on the lighting in advance, e.g. at dusk, wait for the desired brightness level, then slowly turn the LUX knob from night (☾) to daylight (☀) while someone is passing through the centre of the detection area. When the light is on, release the LUX knob. You may need to make further adjustments to achieve the desired brightness level setting.

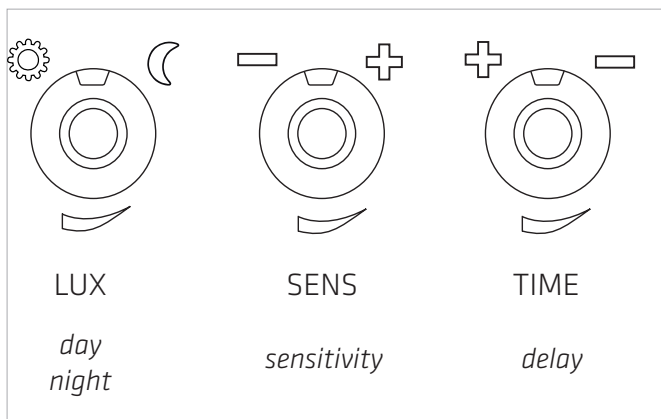

The manufacturer reserves the right to make constructional changes in the course of product improvement or upgrade the presented product. The product specification sheet is not a commercial offer.

Sheet update date: 06/08/2014



Lena Lighting S.A.
ul. Kórnicka 52
63-000 Środa Wielkopolska

tel. +48 (61) 28 60 300
fax +48 (61) 28 54 059
email: office@lenalighting.pl
www.lenalighting.pl



The luminaire meets the requirements of the EU Directive ROHS 2011/65/EU.



This product is subject to the regulations on recycling of electrical and electronic equipment.



CE No. 31/2014

DALI PIR Motion Sensor with Bluetooth® 5.0 SIG Mesh

WSE0015 (HCD049/BT) (High-bay)
DALI/DALI-2 Bolt-on/Batten-fit PIR Sensor



Product Description

HCD049/BT is a Bluetooth DALI/DALI-2 high-bay PIR motion sensor, with capability of up to 1.5m installation height. HCD049/BT has a daylight sensor built-in, and is specifically designed for mounting onto a batten style luminaire. It is also designed for professional lighting manufacturers who would like to incorporate wireless control into their luminaires. HCD049/BT is suitable for any typical indoor applications such as office, classroom, car park, warehouse and other commercial/industrial areas. With Bluetooth wireless mesh networking, it makes communication much easier without any hardwiring, which eventually adds values to luminaires and saves costs for projects. Meanwhile, simple device setup and commissioning can be done via Lena Lighting Clue app..



App Features

- Floorplan feature to simplify project planning
- Grouping luminaires via mesh network
- Scenes
- Detailed motion sensor settings
- Schedule to run scenes based on time and date
- Astro timer (sunrise and sunset)
- Staircase function (master & slave)
- Device firmware update over-the-air (OTA)
- Power-on status (memory against power loss)
- Offline commissioning
- Different permission levels via authority management
- Network sharing via QR code or keycode
- Remote control via gateway support HBGW01
- Interoperability with Hytronik Bluetooth product portfolio
- Continuous development in progress...

Hardware Features

- 30mA DALI Broadcast output
- IP65
- Fixing washers accessory
- High-bay (up to 1.5m height)
- 5-year warranty, designed for long lifetime up to 50,000 hours

Smartphone app for both iOS & Android platform

Web app/platform: www.iot.koolmesh.com

Technical Specifications

Input Characteristics

Model No.	HCD049/BT
Operating voltage	220 ~ 240VAC 50/60Hz
Stand-by power	< 1W
Output	30mA, 12VDC (max. 15 devices)
Warming-up	30s

Safety and EMC

EMC standard (EMC)	EN55015, EN61547 EN61000-3-2/-3-3
Safety standard (LVD)	EN61347-1, EN61347-2-11
Certification	ENEC, CE, EMC, LVD, RCM
RED	EN300328, EN301489-1 EN301489-17

Sensor Data

Model No.	HCD049/BT
Sensor principle	PIR detection
Detection range*	Max installation height: 15m (forklift) 12m (single person) Max detection range: 16m (diameter)
Detection angle	360°

* The detection range is heavily influenced by sensor placement (angle) and different walking paces. It may be reduced under certain conditions.

Environment

Operation temperature	Ta: -20°C ~ +50°C
IP rating	IP65

Mechanical Structure & Dimensions

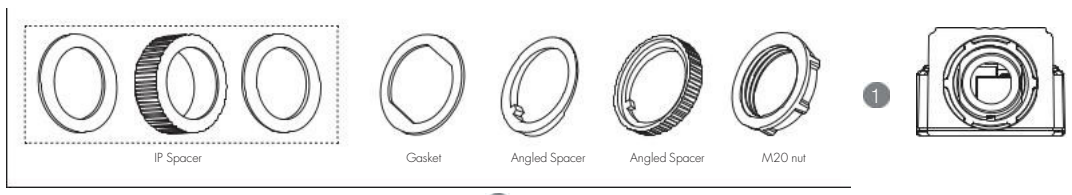
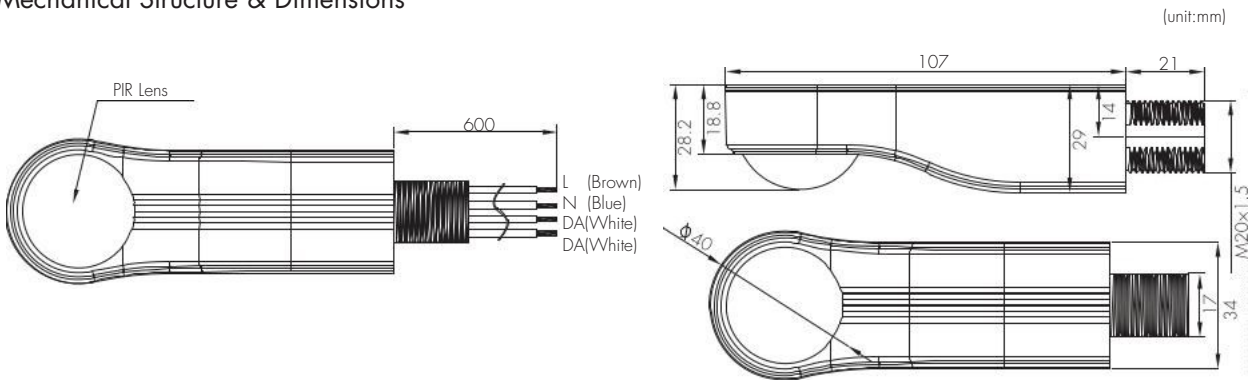

Typical Installation 1

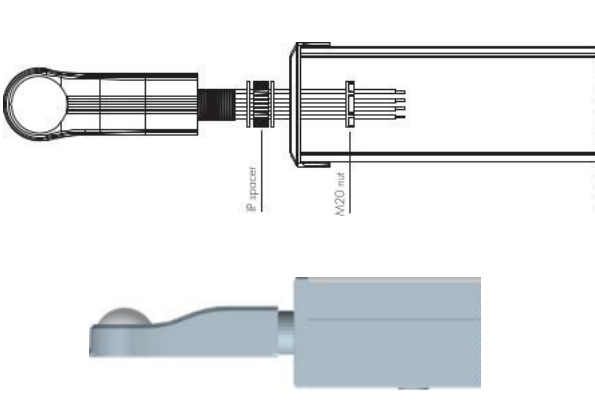

Typical Installation 2

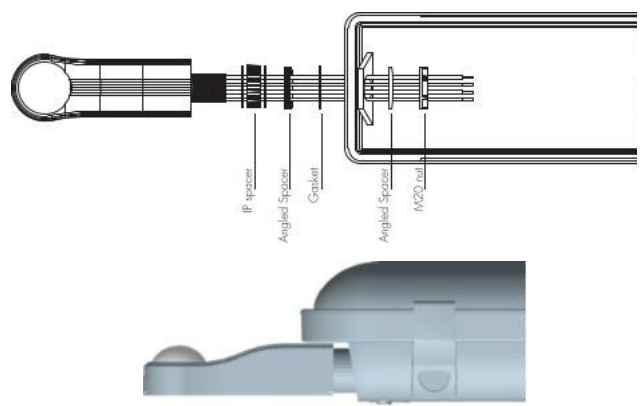

Wiring Diagram

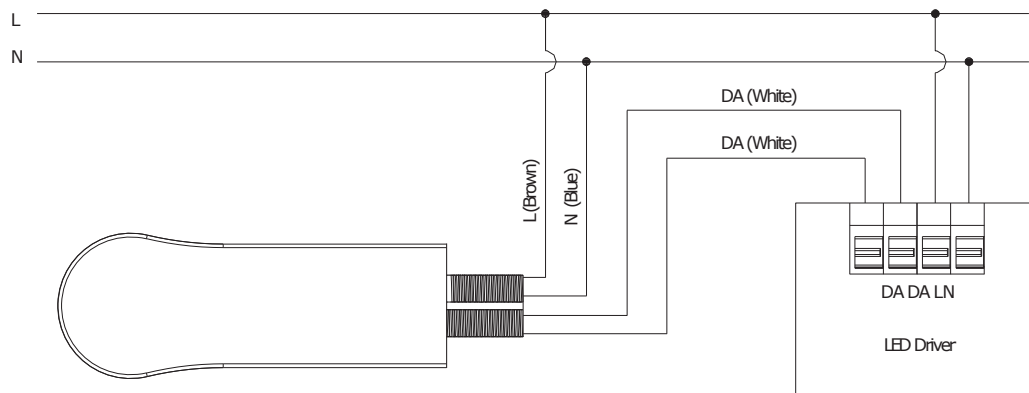

Detection Pattern

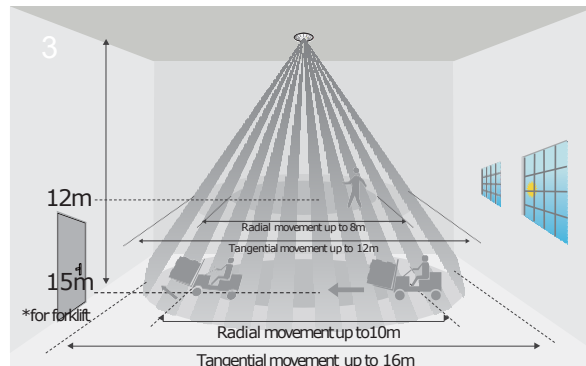

*The detection patterns are based upon 5km/h movement speed.

Additional Information / Documents

1. To learn more about detailed product features/functions, please refer to www.hytronik.com/download ->knowledge ->Introduction of App Scenes and Product Functions
2. Regarding precautions for Bluetooth product installation and operation, please kindly refer to www.hytronik.com/download ->knowledge ->Bluetooth Products -Precautions for Product Installation and Operation
3. Regarding precautions for PIR sensor installation and operation, please kindly refer to www.hytronik.com/download ->knowledge ->PIR Sensors -Precautions for Product Installation and Operation
4. Data sheet is subject to change without notice. Please always refer to the most recent release on www.hytronik.com/products/bluetooth technology ->Bluetooth Sensors
5. Regarding Hytronik standard guarantee policy, please refer to www.hytronik.com/download->knowledge ->Hytronik Standard Guarantee Policy

WSED414 (HIM14)

HF and PIR, Daylight harvest Control for Independent DALI

Mechanical Structure

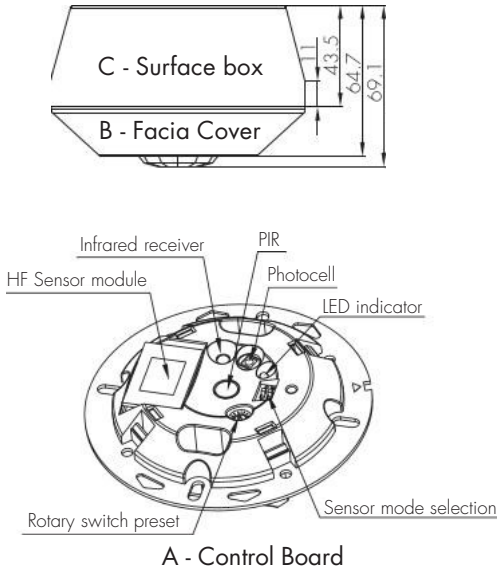

Note: the blinds are optional, they may be inserted behind the lens for focussing the detection range.

Installation:

For more details, please refer to user manual.

- 1 Direct junction "J" box mounting



- 2 Surface mount assembly



Note: We recommend the mounting distance between sensor to sensor should be more than 2m to prevent sensors from false-triggering.

Technical Data

Input Characteristics

Model No.	HIM14
Mains voltage	120~277VAC 50/60Hz
Stand-by power	<1W
Switched power	Max. 20pcs devices, 40mA
Warming-up	30s

Safety and EMC

EMC standard (EMC)	EN55015, EN61000
Safety standard (LVD)	EN60669, AS/NZS60669
Radio Equipment (RED)	EN300440, EN301489-1, EN62479
Certification	Semko, CB, CE, EMC, RED, RCM

Sensor Data

Model No.	HIM14
Sensor principle	High Frequency (microwave), PIR
Operation frequency	5.8GHz +/- 75MHz (HF)
Transmission power	<0.2mW (HF)
Sensor mode	4 modes: PIR, HF, PIR+HF, PIR/HF
Detection range	
HIM14	Max. (∅ x H) 12m x 6m
HIM54 (2 lens)	Max. (∅ x H) 16m x 12m
	Max. (L x W x H) 16m x 6m x 12m
Detection angle	360°

Environment

Operation temperature	Ta: -20°C ~ +55°C
IP rating	IP20



Dual Sense Introduction

It's commonly known Microwave and Infrared are main detecting technologies in lighting controls. Both have the advantage and disadvantage for industrial applications.

Advantage

- * sensitive to minor motion.
- * sensitive to radial movement.
- * can be reflected by objects hence covering big detection area
- * resilient to heat source, smoke and air conditioner.



Advantage

- * no penetration, confined detection area.
- * sensitive to tangential movement.
- * resilient to motion object which has no heat radiation.



Disadvantage

- * penetrates walls, picks up motions outside of the office area;
- * back wave detection, false trigger by motions at the back.
- * can be false triggered by ventilation fans, water pipe, elevators etc. in industrial application.

Disadvantage

- * can be false triggered by air conditioner, smoke and other heat sources.

The remedy is to create Dual Sense by combining both technologies to make use of the advantage and bypass the disadvantage.

4 optional detection modes via DIP switch or remote control:

- * HF: Microwave only
- * PIR: PIR mode only
- * HF+PIR: both PIR and microwave mode, to decrease the detection capability and detection area. Only when both detections are activated, the motion is considered valid. This is to prevent the sensor from false trigger by heat source, air conditioner, ventilation fans, water pipe and elevators etc...
- * HF/PIR: either PIR or microwave mode, to increase the detection capability and detection area;

	1	2	
I	●	●	HF
II	○	●	PIR
III	●	○	HF+PIR
IV	○	○	HF/PIR



Functions and Features

1 Daylight Harvest



Light will not switch on when natural light is sufficient, even there is motion detected.



The light switches on automatically with presence when natural light is insufficient.



The light turns on at full or dims to maintain the lux level. The light output regulates according to the level of natural light available.





The light switches off when the ambient natural light is sufficient.



The light dims to stand-by period after hold-time and stays on selected minimum dimming level.



The light switches off completely after the stand-by period.

Note:
The light automatically dims down and eventually turns off if the natural light lux level exceeds the daylight threshold. However, if the stand-by period is preset at "+∞", the fixture never switches off but dim to minimum level, even the natural light is sufficient.

Settings (Remote Control HRC-11)



Permanent ON/OFF function

Press button "ON/OFF" to select permanent ON or permanent OFF mode.
* Press button "AUTO", "RESET" to quit this mode.
The mode will change to AUTO Mode after power failure.



Reset Settings

Press button "RESET", all settings go back to rotary switch settings. Sensor detection mode returns to DIP switch settings.



Shift Button

Press button "Shift", the LED on the top left corner will flash to indicate mode selection. All values / settings in RED are valid for 20 seconds.



AUTO mode

Press button "AUTO" to initiate automatic mode. The sensor starts working and all settings remain as before the light is switched ON/OFF.



SEMI-AUTO mode

1. Press button "Shift", the red LED flashes for indication.
2. Press button "SEMI-AUTO/AUTO" to initiate semi-auto mode. The fixture is manually turned on by pressing the push-switch, and goes off automatically in this mode. (Absence detection mode)



Power output

Press the buttons to select light output at 80% (at initial 10,000 hours) or 100%.
Note: "Sensor off" and "Twilight" functions are disabled.



Brightness +/-

Press the buttons to adjust the light brightness to reset the target lux level.



HRC-11



Scene program - 1-key commissioning

1. Press button "Start" to program.
2. Select the buttons in "Detection range", "Daylight threshold", "Hold-time", "Stand-by time", "Stand-by dimming level" to set all parameters.
3. Press button "Memory" to save all the settings programmed in the remote control.
4. Press button "Apply" to set the settings to each sensor unit(s).

For example, to set detection range 100%, daylight threshold Disable, hold-time 5min, stand-by time $+\infty$, stand-by dimming level 30%, the steps should be: Press button "Start", button "100%", "Disable", "Shift", "5min", "Shift", " $+\infty$ ", "30%", "Memory". By pointing to the sensor unit(s) and pressing "Apply", all settings are passed on the sensor(s).

Detection range

Press buttons in zone "Detection range" to set detection range at 100% / 75% / 50% / 10%.

Daylight threshold

Press buttons in zone "Daylight threshold" to set daylight sensor / target lux level at 50Lux / 100Lux / 300Lux / 500Lux / Disable.

Note: 2lux / 10lux are disabled.

To set daylight sensor at 100Lux / 300Lux / 500Lux, press "Shift" button first.

Ambient daylight threshold

1. Press button "Shift", the red LED starts to flash.
2. Press button "Ambient", the surrounding lux level is sampled and set as the new daylight threshold / target lux level.

Hold-time

Press buttons in zone "hold-time" to set the hold-time at 2s / 30s / 1min / 5min / 10min / 15min / 20min / 30min.

Note: 1. To set hold-time at 30s / 5min / 15min / 30min, press "Shift" button first.

2. 2s is for testing purpose only, stand-by period and daylight sensor settings are disabled in this mode.

**To exit from Test mode, press button "RESET" or any button in "Hold-time".*

Stand-by time (corridor function)

Press buttons in zone "stand-by time" to set the stand-by period at 0s / 10s / 1min / 5min / 10min / 30min / 1h / $+\infty$.

Note: "0s" means on/off control; " $+\infty$ " means bi-level control, the fixture is 100% on when there is motion detected, and remains at the stand-by dimming level when no presence after motion hold-time.

Stand-by dimming level

Press the button in zone "stand-by dimming level" to set the stand-by dimming level at 10% / 20% / 30% / 50%.

Daylight harvest auto-configuration function

1. Press button "Shift", the red LED starts to flash.
2. Select a time period and the sensor will do light level measurement and determine/save the lowest light level (commission line) with 100% light on, so as to set the target lux level automatically.

Note: 1. Make sure the light level measurement covers the night time.

2. The fixture will go into sensor mode after the measurement, all sensor settings remain unchanged.

Dual tech & RF mode

1. Press buttons in this zone to select sensor technology.
 - HF+PIR: the light is on when both HF and PIR sensors are activated.
 - HF/PIR: the light is on when HF or PIR sensors are activated.
2. Learn / Erase, Transmit, RX100% and RX STBY% are disabled.

Rotary Switch Preset

A rotary switch is built inside the sensor for scene selection / fast programming. Total 16 channels are available:



Rotary switch preset

Note: settings can also be changed by remote control HRC-11. The last action controls.

Channel	Detection range	Hold-time	Daylight sensor	Stand-by time	Stand-by dim level
0	100%	5s	Disable	10s	10%
1	100%	1min	50Lux	5min	10%
2	100%	5min	50Lux	10min	10%
3	100%	5min	75Lux	+∞	10%
4	100%	5min	100Lux	+∞	10%
5	100%	5min	200Lux	+∞	30%
6	100%	10min	50Lux	30min	10%
7	100%	10min	75Lux	+∞	10%
8	100%	10min	100Lux	+∞	10%
9	100%	10min	200Lux	+∞	30%
A	100%	20min	100Lux	1h	10%
B	100%	20min	200Lux	+∞	30%
C	100%	30min	100Lux	+∞	10%
D	100%	30min	200Lux	+∞	30%
E	100%	30min	400Lux	+∞	50%
F	100%	5s	100Lux	10s	10%

Wiring Diagram

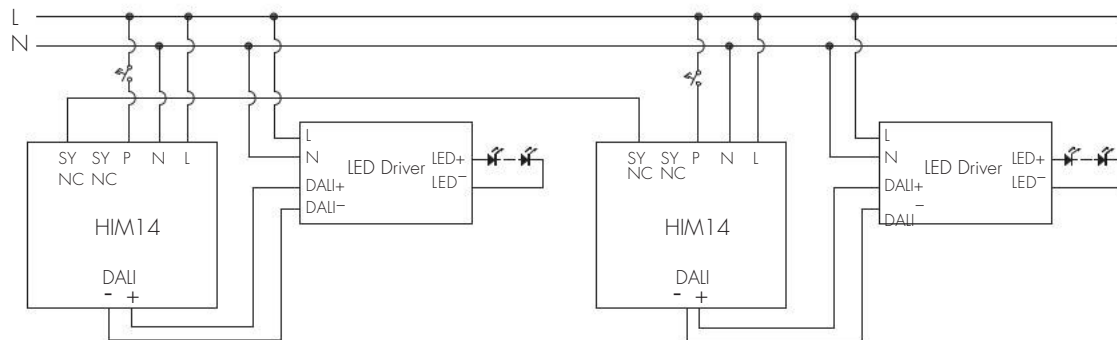

Detection Pattern

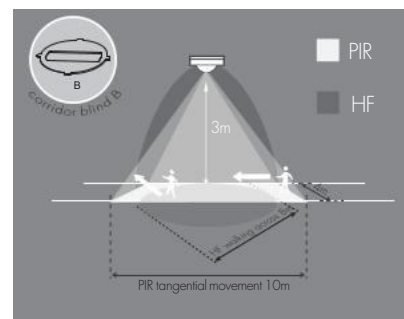
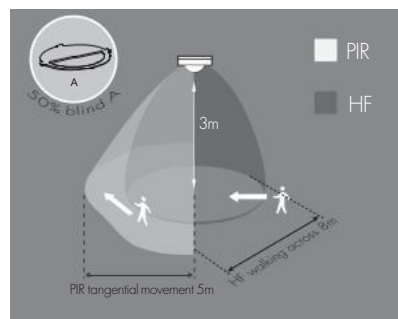
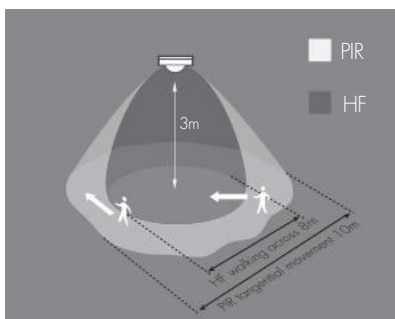

Additional Information / Documents

1. Regarding precautions for microwave sensor installation and operation, please kindly refer to [www.hytronik.com/download ->knowledge ->Microwave Sensors - Precautions for Product Installation and Operation](http://www.hytronik.com/download->knowledge->Microwave+Sensors+-+Precautions+for+Product+Installation+and+Operation)
2. Regarding precautions for PIR sensor installation and operation, please kindly refer to [www.hytronik.com/download ->knowledge ->PIR Sensors - Precautions for Product Installation and Operation](http://www.hytronik.com/download->knowledge->PIR+Sensors+-+Precautions+for+Product+Installation+and+Operation)
3. Regarding Hytronik standard guarantee policy, please refer to [www.hytronik.com/download ->knowledge ->Hytronik Standard Guarantee Policy](http://www.hytronik.com/download->knowledge->Hytronik+Standard+Guarantee+Policy)

IP65 On/off PIR Motion Sensor (High-bay)

WSEL380 (HC049S) (High-bay)

On/off Bolt-on/Batten-fit PIR Sensor



Product Description

HC049S is a high-bay PIR on/off motion sensor, with capability of up to 1.5m installation height. HC049S has a daylight sensor built-in, and is specifically designed for mounting onto a batten style luminaire. All sensor parameters can be programmed through remote controller HRC-11.

Hardware Features

- IP65
- Max withstand in-rush current 80A@160μs
- Black, white gray metal Surface mount box optional
- Fixing washers accessory
- High-bay (up to 1.5m height)
- 5-year warranty, designed for long lifetime up to 50,000 hours
- Remote controllable



Technical Specifications

Input Characteristics

Model No.	HC049S
Operating voltage	220 ~ 240VAC 50/60Hz
Stand-by power	< 1W
Output	30mA, 12VDC (max. 15 devices)
Warming-up	30s

Safety and EMC

EMC standard (EMC)	EN55015, EN61547 EN61000-3-2/-3-3
Safety standard (LVD)	EN61347-1, EN61347-2-11
Certification	ENEC, CE, EMC, LVD, RCM
RED	EN300328, EN301489-1 EN301489-17

Sensor Data

Model No.	HC049S
Sensor principle	PIR detection
Detection range*	Max installation height: 1.5m (forklift) 1.2m (single person) Max detection range: 1.6m (diameter)
Detection angle	360°

* The detection range is heavily influenced by sensor placement (angle) and different walking paces. It may be reduced under certain conditions.

Environment

Operation temperature	Ta: -20°C ~ +50°C
IP rating	IP65

Zero-cross relay operation

The sensor switches on/off the load right at the zero-cross point, to ensure that the in-rush current is minimised, enabling the maximum lifetime of the relay.

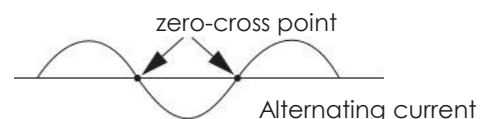

Mechanical Structure & Dimensions

(unit:mm)

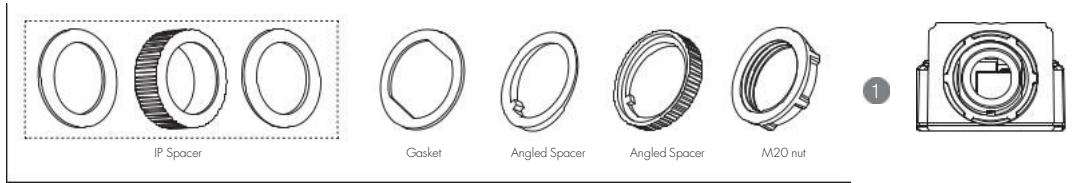
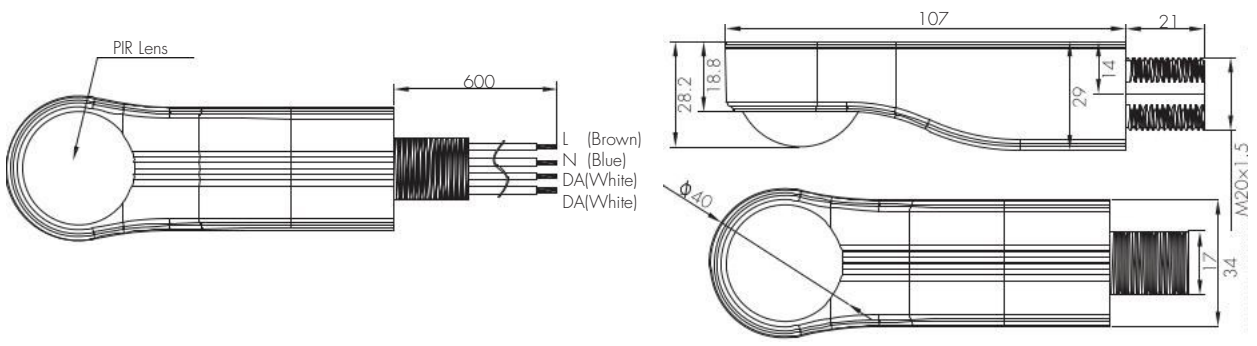

Typical Installation 1

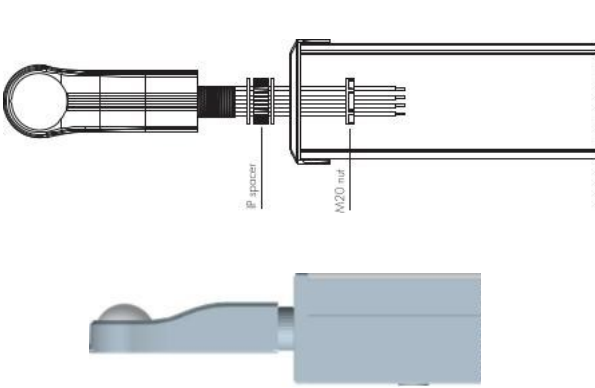

Typical Installation 2

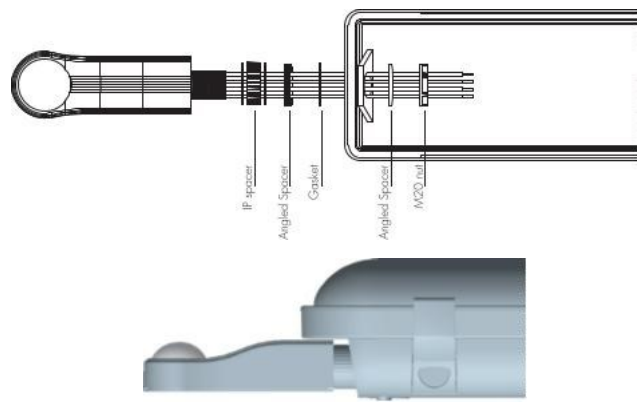

Wiring Diagram

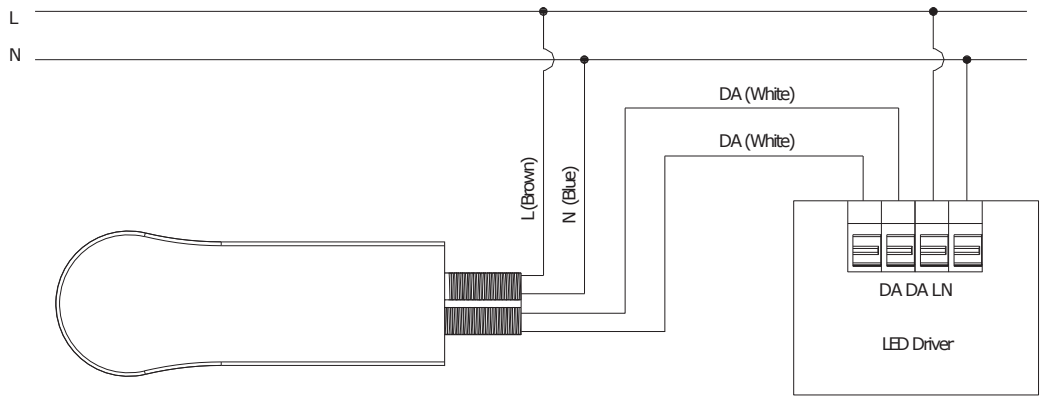

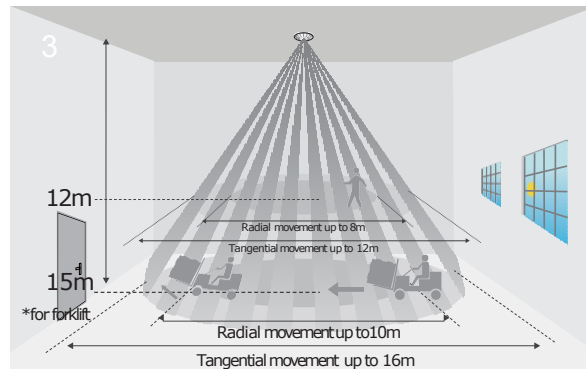

*The detection patterns are based upon 5km/h movement speed.

Additional Information / Documents

1. To learn more about detailed product features/functions, please refer to www.hytronik.com/download ->knowledge ->Introduction of App Scenes and Product Functions
2. Regarding precautions for Bluetooth product installation and operation, please kindly refer to www.hytronik.com/download ->knowledge ->Bluetooth Products -Precautions for Product Installation and Operation
3. Regarding precautions for PIR sensor installation and operation, please kindly refer to www.hytronik.com/download ->knowledge ->PIR Sensors -Precautions for Product Installation and Operation
4. Data sheet is subject to change without notice. Please always refer to the most recent release on www.hytronik.com/products/bluetooth technology ->Bluetooth Sensors
5. Regarding Hytronik standard guarantee policy, please refer to www.hytronik.com/download->knowledge ->Hytronik Standard Guarantee Policy

624193 | WSE0010 | 624506 | 625404 (HBIR29)























One DALI output









Product Description

HBIR29 series are Bluetooth PIR standalone motion sensors with one DALI channel output (80mA DALI power supply built in), which can control up to 40 LED drivers. It is ideal for typical indoor applications such as office, classroom, healthcare and other commercial areas. With Bluetooth wireless mesh networking, it makes communication between luminaires much easier without time-consuming hardwiring, which eventually saves costs for projects (especially for retrofit upgrade projects!). Meanwhile, simple device setup and commissioning can be done via Lena Lighting Clue app.











App Features

-  Quick setup mode & advanced setup mode
-  Web app/platform for project deployment & data analysis
-  Koolmesh Pro app on iPad for on-site configuration
-  Floorplan feature to simplify project planning
-  coming soon
-  One-key device replacement
-  Device social relations check
-  Staircase function (primary & secondary)
-  Remote control via gateway support HBGW01
-  Heat map
-  Dynamic daylight harvest auto-adaptation
-  Grouping luminaires via mesh network
-  Scenes
-  Dusk/Dawn photocell (Twilight function)
-  Tri-level control
-  Daylight harvest
-  Circadian rhythm (Human centric lighting)
-  Push switch configuration
-  Detailed motion sensor settings
-  Schedule
-  Astro timer (sunrise and sunset)
-  Power-on status (memory against power loss)
-  Offline commissioning

-  Bulk commissioning (copy and paste settings)
-  Different permission levels via authority management
-  Network sharing via QR code or keycode
-  Interoperability with Hytronik Bluetooth product portfolio
-  Compatible with EnOcean BLE switches
-  Internet-of-Things (IoT) featured
-  Device firmware update over-the-air (OTA)
-  Continuous development in progress...

Hardware Features

-  80mA DALI broadcast output
-  Support to control DT8 LED drivers
-  2 Push inputs for flexible manual control
-  IP20/IP54 Ceiling/Surface mount box available as accessory
-  Two types of blind inserts / blanking plates
-  User-friendly design for installation
-  High bay version available (up to 1.5m in height)
-  5-year warranty



Fully support EnOcean self-powered switch module PTM215B (HBES01/W & HBES01/B)

Smartphone app for both
iOS & Android platform

Web app/platform:
www.iot.koolmesh.com

Technical Specifications

Bluetooth Transceiver	
Operation frequency	2.4 GHz - 2.483 GHz
Transmission power	4 dBm
Range (Typical indoor)	10~30m
Protocol	5.0 SIG Mesh

Input & Output Characteristics	
Operating voltage	220~240VAC 50/60Hz
Stand-by power	< 1W
Switched power	Max. 40 devices, 80mA
Warming-up	20s

Sensor Data	
Sensor Model	PIR detection
HBIR29	Installation Height : 6m Detection Range(Ø) : 9m
HBIR29/R	Installation Height : 6m Detection Range(Ø) : 10m
HBIR29/W	Installation Height : 6m Detection Range(Ø) : 18m
HBIR29/H	Installation height: 1.5m (forklift) 12m (person) Detection range (Ø): 24m
Detection angle	360°

Safety & EMC	
EMC standard (EMC)	EN55015, EN61000, EN61547
Safety standard (LVD)	EN60669-1, EN60669-2-1 AS/NZS60669-1/-2-1
RED	EN300328, EN301489-1/-17
Certification	CB, CE, EMC, RED, RCM

Environment	
Operation temperature	Ta: -20°C ~ +50°C
IP rating	IP20

* For more details of detection range, please refer to "detection pattern" section.

Mechanical Structure & Dimensions

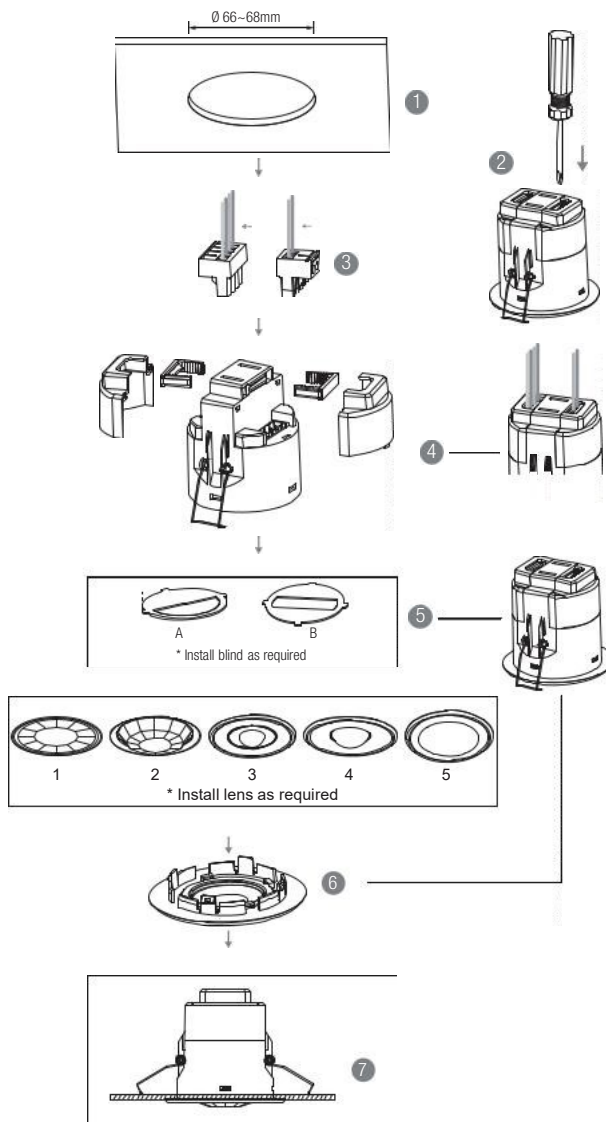

1. Ceiling (drill hole \varnothing 66-68mm)
2. Carefully prise off the cable clamps.
3. Make connections to the pluggable terminal blocks.
4. Insert plug connectors and secure using the provided cable clamps, then clip terminal covers to the base.
5. Fit detection blind (if required) and desired lens.
6. Clip fascia to body.
7. Bend back springs and insert into ceiling.

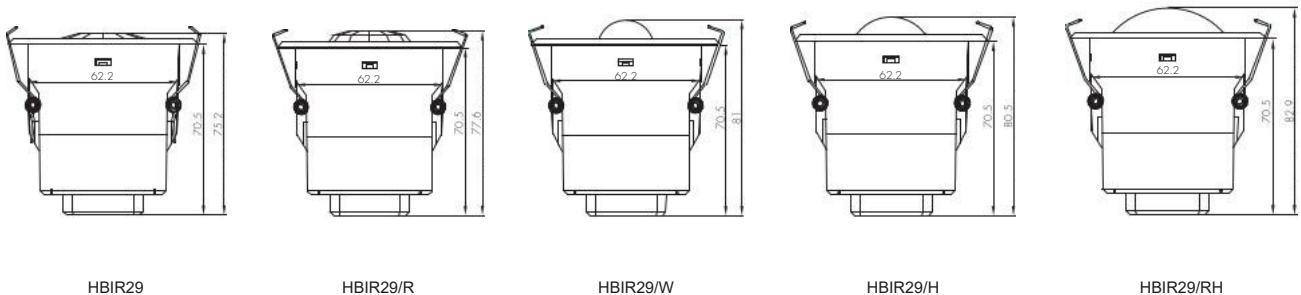
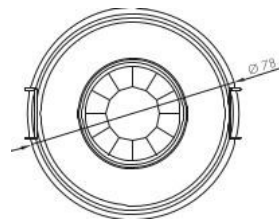

Wiring Diagram

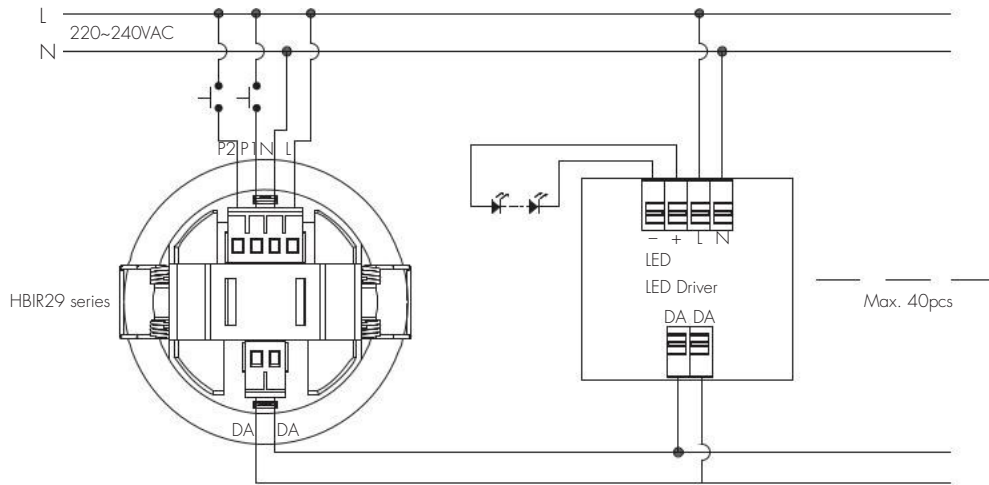

Wire Preparation

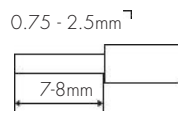

Pluggable screw terminal. It is recommended to make connections to the terminal before fitting to the sensor.

1. 200 metres (total) max. for 1 mm² CSA (Ta = 50°C)
2. 300 metres (total) max. for 1.5 mm² CSA (Ta = 50°C)

Placement Guide and Typical Range

Smart Phone to Device Range



The smart device with the App installed will have a typical range of 10m, but varies from device to device. During commissioning, the installer will need to be in range of the devices when searching for devices to add to the network.

Once the devices have been added to the network via the App, the devices will start communicating within the wireless mesh. This means that once the network is complete, all devices are accessible from the smart device when in a 20m range of a single point.

1. HBIR29 (Low-bay)



HBIR29: Low-bay flat lens detection pattern for **single person** @ $T_a = 20^{\circ}\text{C}$

(Recommended ceiling mount installation height **2.5m-6m**)

A: Tangential movement	B: Radial movement	Mount height	Tangential (A)	Radial (B)
		2.5m	max 50m ² (Ø = 8m)	max 13m ² (Ø = 4m)
		3m	max 64m ² (Ø = 9m)	max 13m ² (Ø = 4m)
		4m	max 38m ² (Ø = 7m)	max 13m ² (Ø = 4m)
		5m	max 38m ² (Ø = 7m)	max 13m ² (Ø = 4m)
		6m	max 38m ² (Ø = 7m)	max 13m ² (Ø = 4m)

Optional Accessory --- Ceiling/Surface Metal Mount Box: HA09/W, HA09/B, HA09/G

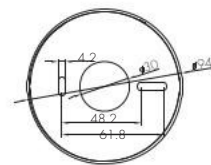
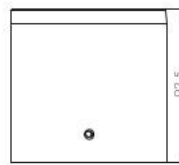

Optional Accessory --- Blind Insert for Blocking Certain Detection Angles



Blind Option 1 --- Aisle Detection



Blind Option 2 --- 180° Detection

2. HBIR29/R (Reinforced Low-bay)



HBIR29/R: Low-bay convex lens detection pattern for **single person** @ Ta = 20°C

(Recommended ceiling mount installation height **2.5m-6m**)

A: Tangential movement	B: Radial movement	Mount height	Tangential (A)	Radial (B)
		2.5m	max 79m ² (∅ = 10m)	max 20m ² (∅ = 5m)
		3m	max 79m ² (∅ = 10m)	max 20m ² (∅ = 5m)
		4m	max 64m ² (∅ = 9m)	max 20m ² (∅ = 5m)
		5m	max 50m ² (∅ = 8m)	max 20m ² (∅ = 5m)
		6m	max 50m ² (∅ = 8m)	max 20m ² (∅ = 5m)

Optional Accessory --- Ceiling/Surface Metal Mount Box: HA09/W, HA09/B, HA09/G

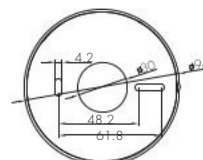
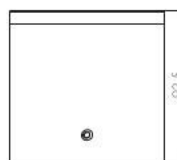

Optional Accessory --- Blind Insert for Blocking Certain Detection Angles



Blind Option 1 --- Aisle Detection



Blind Option 2 --- 180° Detection

3. HBIR29/W (Wide range Low-bay)



HBIR29/W: Low-bay convex lens detection pattern for **single person** @ $T_a = 20^\circ\text{C}$

(Recommended ceiling mount installation height **2.5m-6m**)

A: Tangential movement	B: Radial movement	Mount height	Tangential (A)	Radial (B)
		2.5m	max 254m ² (Ø = 18m)	max 28m ² (Ø = 6m)
		3m	max 254m ² (Ø = 18m)	max 28m ² (Ø = 6m)
		4m	max 154m ² (Ø = 14m)	max 28m ² (Ø = 6m)
		5m	max 113m ² (Ø = 12m)	max 28m ² (Ø = 6m)
		6m	max 79m ² (Ø = 10m)	max 13m ² (Ø = 4m)

Optional Accessory --- Ceiling/Surface Metal Mount Box: HA09/W, HA09/B, HA09/G

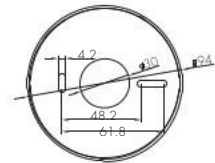
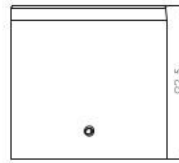

4. HBIR29/H (High-bay)

HBIR29/H: High-bay lens detection pattern for forklift @ Ta = 20°C

(Recommended ceiling mount installation height **10m-15m**)

A: Tangential movement	B: Radial movement	Mount height	Tangential (A)	Radial (B)
		10m	max 380m ² (Ø = 22m)	max 201m ² (Ø = 16m)
		11m	max 452m ² (Ø = 24m)	max 201m ² (Ø = 16m)
		12m	max 452m ² (Ø = 24m)	max 201m ² (Ø = 16m)
		13m	max 452m ² (Ø = 24m)	max 177m ² (Ø = 15m)
		14m	max 452m ² (Ø = 24m)	max 133m ² (Ø = 13m)
		15m	max 452m ² (Ø = 24m)	max 113m ² (Ø = 12m)

HBIR29/H: High-bay lens detection pattern for single person @ Ta = 20°C

(Recommended ceiling mount installation height **2.5m-12m**)

A: Tangential movement	B: Radial movement	Mount height	Tangential (A)	Radial (B)
		2.5m	max 50m ² (Ø = 8m)	max 7m ² (Ø = 3m)
		6m	max 104m ² (Ø = 11.5m)	max 7m ² (Ø = 3m)
		8m	max 154m ² (Ø = 14m)	max 7m ² (Ø = 3m)
		10m	max 227m ² (Ø = 17m)	max 7m ² (Ø = 3m)
		11m	max 269m ² (Ø = 18.5m)	max 7m ² (Ø = 3m)
		12m	max 314m ² (Ø = 20m)	max 7m ² (Ø = 3m)

Optional Accessory -- Ceiling/Surface Metal Mount Box: HA09/W, HA09/B, HA09/G

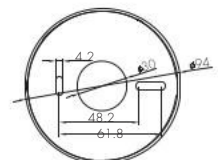
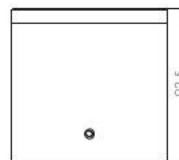

Optional Accessory -- Blind Insert for Blocking Certain Detection Angles

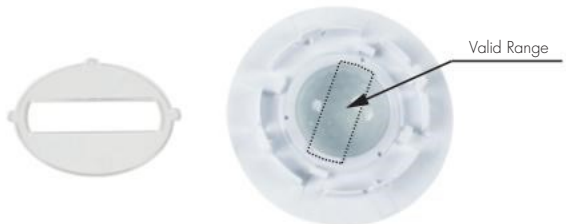

Blind Option 1 --- Aisle Detection



Blind Option 2 --- 180° Detection

Small silicon water-proof gasket dimension(size:mm)

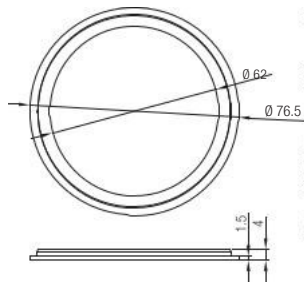

Big silicon water-proof gasket dimension(size:mm)

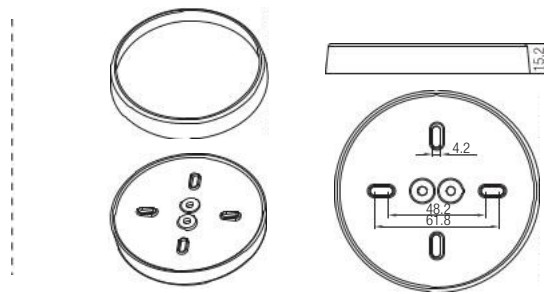

Additional Information / Documents

1. To learn more about detailed product features/functions, please refer to [www.hytronik.com/download ->knowledge ->Introduction of App Scenes and Product Functions](http://www.hytronik.com/download->knowledge->Introduction%20of%20App%20Scenes%20and%20Product%20Functions)
2. Regarding precautions for Bluetooth product installation and operation, please kindly refer to [www.hytronik.com/download ->knowledge ->Bluetooth Products - Precautions for Product Installation and Operation](http://www.hytronik.com/download->knowledge->Bluetooth%20Products%20-%20Precautions%20for%20Product%20Installation%20and%20Operation)
3. Regarding precautions for PIR Sensors installation and operation, please kindly refer to [www.hytronik.com/download ->knowledge ->PIR Sensors - Precautions for Product Installation and Operation](http://www.hytronik.com/download->knowledge->PIR%20Sensors%20-%20Precautions%20for%20Product%20Installation%20and%20Operation)
4. Data sheet is subject to change without notice. Please always refer to the most recent release on [www.hytronik.com/products/bluetooth technology ->Bluetooth Sensors](http://www.hytronik.com/products/bluetooth%20technology->Bluetooth%20Sensors)
5. Regarding Hytronik standard guarantee policy, please refer to [www.hytronik.com/download ->knowledge ->Hytronik Standard Guarantee Policy](http://www.hytronik.com/download->knowledge->Hytronik%20Standard%20Guarantee%20Policy)

DALI PIR Motion Sensor with HRC-11 Remote Control

WSEL381 (HCD049) (High-bay)
DALI/DALI-2 Bolt-on/Batten-fit PIR Sensor



LENA
LIGHTING

Clue[®]



IP65

Product Description

HCD049 is a DALI high-bay PIR motion sensor, with capability of up to 1.5m installation height. HCD049 has a daylight sensor built-in, and is specifically designed for mounting onto a batten style luminaire. All sensor parameters can be programmed through remote controller HRC-11.

Hardware Features

- 30mA DALI Broadcast output
- IP65
- Fixing washers accessory
- High-bay (up to 1.5m height)
- 5-year warranty, designed for long lifetime up to 50,000 hours
- Daylight Harvest
- Remote controllable



Technical Specifications

Input Characteristics

Model No.	HCD049
Operating voltage	220 ~ 240VAC 50/60Hz
Stand-by power	< 1W
Output	30mA, 12VDC (max. 15 devices)
Warming-up	30s

Safety and EMC

EMC standard (EMC)	EN55015, EN61547 EN61000-3-2/-3-3
Safety standard (LVD)	EN61347-1, EN61347-2-11
Certification	ENEC, CE, EMC, LVD, RCM
RED	EN300328, EN301489-1 EN301489-17

Sensor Data

Model No.	HCD049
Sensor principle	PIR detection
Detection range*	Max installation height: 1.5m (forklift) 1.2m (single person) Max detection range: 1.6m (diameter)
Detection angle	360°

* The detection range is heavily influenced by sensor placement (angle) and different walking paces. It may be reduced under certain conditions.

Environment

Operation temperature	Ta: -20°C ~ +50°C
IP rating	IP65

Mechanical Structure & Dimensions

(unit:mm)

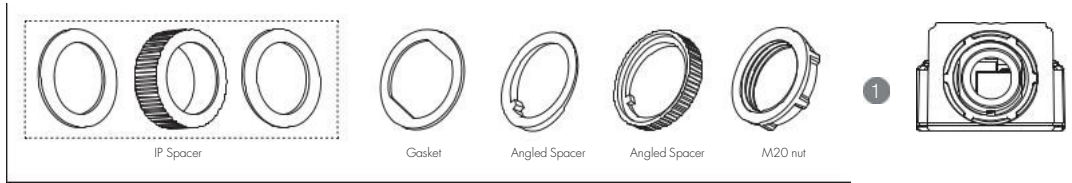
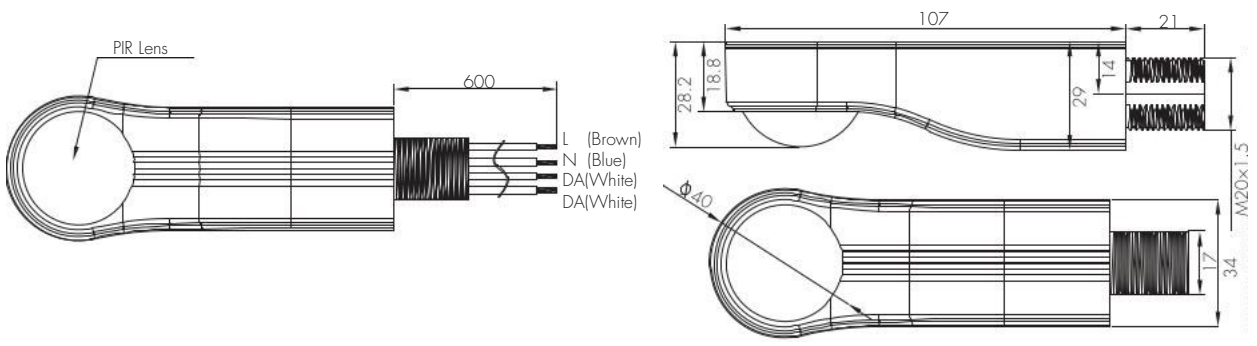

Typical Installation 1

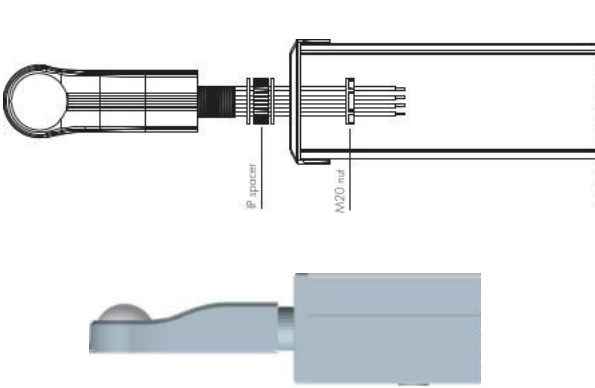

Typical Installation 2

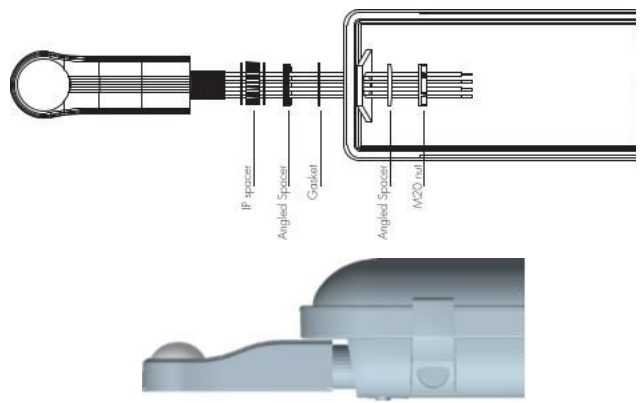

Wiring Diagram

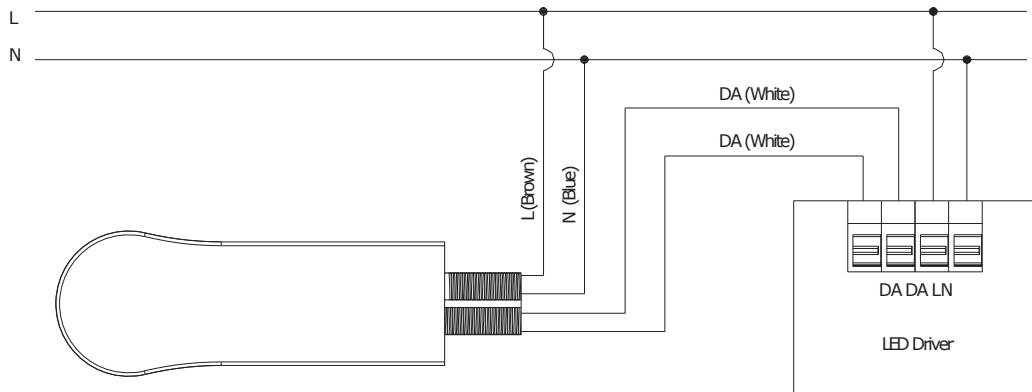

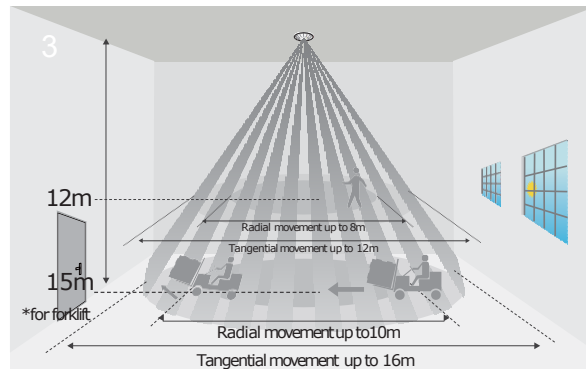

*The detection patterns are based upon 5km/h movement speed.

Additional Information / Documents

1. To learn more about detailed product features/functions, please refer to www.hytronik.com/download ->knowledge ->Introduction of App Scenes and Product Functions
2. Regarding precautions for Bluetooth product installation and operation, please kindly refer to www.hytronik.com/download ->knowledge ->Bluetooth Products -Precautions for Product Installation and Operation
3. Regarding precautions for PIR sensor installation and operation, please kindly refer to www.hytronik.com/download ->knowledge ->PIR Sensors -Precautions for Product Installation and Operation
4. Data sheet is subject to change without notice. Please always refer to the most recent release on www.hytronik.com/products/bluetooth technology ->Bluetooth Sensors
5. Regarding Hytronik standard guarantee policy, please refer to www.hytronik.com/download->knowledge ->Hytronik Standard Guarantee Policy